

# Instruction Manual for Resin Filled LED Underwater Light

This is a high technology electronic controlled light based on LED's in 3/4colors: red, green blue &white. These colors together can produce many other colors to create the perfect atmosphere in the pool. The LED's can also be warm white only or natural white only. The LED's are driven by constant current. High temperature protection makes the LED's be protected while the internal temperature reaches a high level. All these technologies guarantee long working life of the LED lamps. Filled fully with resin, the lights are completely waterproof, and they must be used / operated while fully submerged underwater **only**.

## Technical Specification

Standard input voltage: 12V ; Standard input watt:

SMD2835 LED			
252 LED	333 LED	450 LED	630 LED
18~20W	22~24W	33~35W	40~42W

Use life: 30,000 hours

Single color : Cool White ,Pure White , Warm White ,Blue, Red, Green

**RGB & RGBW : Switch control , Remote control , External control modes.**

## To Operate the lights:

### 1. White only, Warm White only, or other single color only lights (12AC/DC ,2 wires out )

These lights are not dimmable, and are not compatible with dimmer switches or dimmer relays . They can be wired into a switch or manually turn ON/OFF the lights.

### 2.1. RGB Switch control mode. (12VAC ,2 wires out) 16 color modes sequence:

1. Evening sea: slow animation blue/purple
2. Evening rivers: slow animation green/yellow
3. Riviera: slow animation blue/cyan
4. White: neutral white
5. Rainbow: slow animation in green/blue/green+blue/red+blue/green+blue/RGB/red
6. River of colors: slow animation in red/green/blue/green+blue/red+blue/green+blue/RGB, followed by program 8
7. Disco: fast animation, (fast-slow) followed by program 5
8. Four seasons: slow animation in red+green/green/green+blue/blue/violet/red
9. Party: fast animation, (fast-slow) followed by program 6
10. White: sun white.
11. Red: red
12. Green: green
13. Blue: blue
14. Green-blue: fixed color green/blue(cyan)
15. Red-green: fixed color red/green(yellow)
16. Blue-red: fixed color blue-red(purple)

### 2.2. RGBW Switch control mode. ( 12VAC ,2 wires out) 15 color modes sequence:

1. Evening sea: slow animation blue/purple
2. Evening rivers: slow animation green/yellow
3. Riviera: slow animation blue/cyan
4. White: sun white
5. Rainbow: R/G/B/W/RW/RG/GW/BW/GB/RB/RGB/RGW/RBW/GBW/RGBW gradual changing
6. Disco: R/G/B/W/RW/RG/GW/BW/GB/RB/RGB/RGW/RBW/GBW/RGBW flashing changing
7. Four seasons: RGBW/RG ↓ B ↓ W ↓ / R ↓ G ↑ /G ↓ B ↑ /B ↓ W ↑ /R ↑ G ↑ B ↑ W fade changing
8. Party: R/G/B/W/RW/RG/GW/BW/GB/RB/RGB/RGW/RBW/GBW/RGBW color jump changing
9. White: **pure white**
10. Red: color red
11. Green: color green
12. Blue: color blue
13. Green-blue: green/blue(cyan)
14. Red-green: red/green(yellow)
15. Blue-red: blue/red(purple)

### To Operate these RGB/RGBW lights:

- The 15/16 pre-programmed effects and combinations may be selected using the on/off switch of your pool lights. Just switch off and switch on within 3 second. **(Switch control)**
- If the light is powered off for more than 20 seconds, it will keep the latest program when it is turned on again.**(Memory Function)**
- To achieve synchronization, confirm all lamps are installed correctly on the same switch, after they are powered off for more than 20 seconds, switch on and switch off continuously 3 times, and then finally turn them on again. They will all go to program 1. **(Re-set Function)**

### 3,RGB/RGBW Remote control mode (12VAC ,2 wires out) (with memory function)

	ON key: Power On	OFF key: Power off
	<b>BRT+ KEY: brightness +,10 grade in total</b> <b>BRT- KEY: /brightness -,10 grade in total</b> <b>B/PU key: slow animation blue/purple</b> <b>G/YE key: slow animation green/yellow</b> <b>B/CY key: slow animation blue/cyan</b> <b>R key: static red color</b> <b>G key: static green color</b> <b>B key: static blue color</b> <b>WHT key: static white color</b> <b>YE key: static yellow color (R+G)</b> <b>CY key: static cyan color (G+B)</b> <b>PU key: static purple color (R+B)</b> <b>Rainbow key: multiple colors gradual changing</b> <b>Four seasons key: multiple colors fade changing</b> <b>DISCO key: multiple colors flash changing</b> <b>PARTY key: multiple colors jump changing</b>	

#### 4.RGBW / RGB External control mode (12V/24VDC ,5 / 4 wires out )

**IMPORTANT:** This section only applies to the RGBW/RGB lights with 5/4 wires out ,12VDC or 24VDC. pool operators can choose to install controllers to build a fine control system .

The specification of the controller and the power supply , especially the input voltage ,must be well known by the users and installers before installation .Failure to do so may cause the injury to person and damage to the lights system .

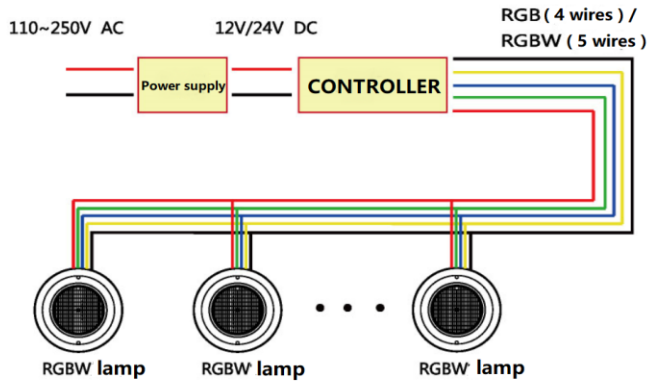

#### Installation

- All lamps should be placed on the wall of the pool at approximately 700mm below the water surface, in areas that are easily accessible from the upper edge of the pool.
- This lamp is designed to be fixed in new pools and/or pools with existing surface mounted lamps that need replacement.

##### 1 Wall-mounted

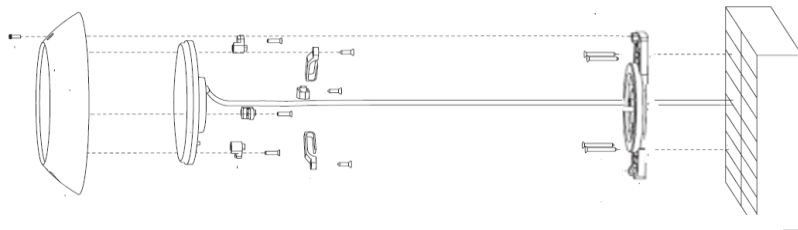

##### 2. Fiber glass

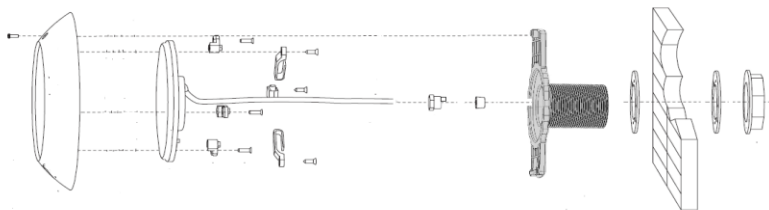

##### 3. Panel & Liner

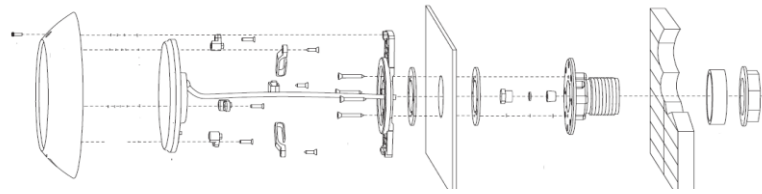

##### 4. Concrete & Liner

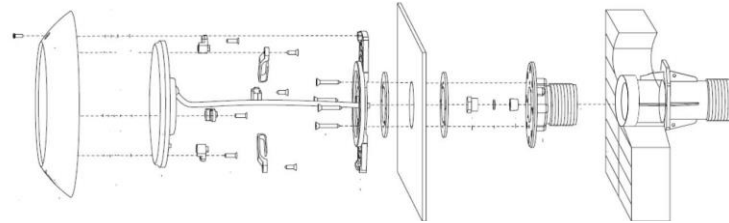

##### 5. Concrete

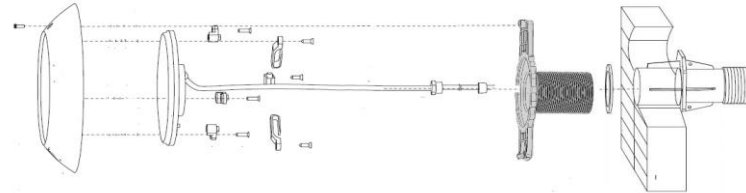

#### Safety Warnings

- **Don't use electronic transformers which may damage the light. You should use industrial frequency transformer , such as toroidal transformer and square transformer .**
- Frequent voltage fluctuations can irreparably damage the lamp. If the installation must take place in areas where these changes may be frequent, a system to protect the lamps must be installed on the electric system of the pool.
- The persons who are in charge of installation should have the required qualifications for this type of work. ● Comply with the current standards regarding accident prevention.
- IEC 364-7-702 standards must be observed: WIRING IN BUILDINGS, SPECIAL WIRING, SWIMMING POOLS. ● Do not handle any electrical components with wet feet

#### Warranty

The manufacturer warrants this resin filled LED underwater lights against defects in materials and workmanship for a period of two years from the date of purchase. This warranty does not cover the fixture becoming damaged due to misuse, accidental damaged, improper handling and/or installation and specifically excludes liability for direct, incidental damages.