Submersible Pump

Installation And Operating Instructions

Models

- **Multi purpose drainage**
Complete RS(T) Drainer series,
Complete JS(T) Drainer series
- **Sewage vortex pump**
Complete JS(T)-SV Vortex series
- **Sewage single channel pump**
Complete JS(T)-S(US) Single Channel series
- **Sewage shredder Pump**
Complete JS(T)-SK Cutter series
- **Sewage grinder Pump**
Complete GS(T) Grinder series



Before USE!

Please read and understand this manual carefully and observe the information contained, before starting to use the submersible pump.

This manual applies to the following models:

Drainage range:

RS-150, RS-250, RS-400, RS-550, RS-750, RS-1500(H), RSD-150, RSD-400
RST-6, RST-8, RST-15(H), RST-22(H), RST-37(H), RST-55(H), RST-75(H)

JS-150, JS-250, JS-400, JS750, JS-1500(H), JS-530
JST8, JST-15(H), JST-22(H), JST-37(H), JST55(H), JST-75(H), JST-110(H), JST-150, JST-220

Drainage cast AISI316 range:

JS-250SS, JS-400SS, JS750SS, JS-1500(H)SS
JST8SS, JST-15(H)SS, JST-22(H)SS, JST-37(H)SS, JST55(H)SS, JST-75(H)SS, JST-110(H)SS, JST-150SS, JST-220SS

Sewage Vortex range:

JS-150SV, JS-250SV, JS-400SV, JS-650SV, JS-750SV
JST-4SV, JST-8SV, JST-15SV, JST-22SV4, JST-37SV, JST-55SV4, JST-75SV4

Sewage single channel range:

JS-750S, JS-1500S
JST-08S, JST-15S, JST-22S, JST-37S, JST-55S4, JST-75S4, JST-110S4

Sewage cast AISI316 single channel range:

JS-750SUS, JS-1500SUS
JST-08SUS, JST-15SUS, JST-22SUS, JST-37SUS, JST-55SUS, JST-75SUS, JST-110SUS4, JST-150SUS4

Sewage shredder range:

JS-750SK, JS-1500SK
JST-08SK, JST-15SK, JST-22SK, JST-37SK, JST-55SK4, JST-75SK4, JST-110SK4, JST-150SK4

Sewage cast AISI316 shredder range:

JS-750SKSS, JS-1500SKSS
JST-08SKSS, JST-15SKSS, JST-22SKSS, JST-37SKSS, JST-55SK4SS, JST-75SK4SS, JST-110SKSS4, JST-150SKSS4

Sewage grinder range:

GS-1200, GS-1500
GST-12, GST-15, GST-22, GST-37

Warranty:

JS will provide warranty on its products only if the following conditions have been met:

- The defect is a direct result of a fault in design, material or assembly.
- The defect has been reported to JS or a certified JS dealer within the warranty period (which is 1 year after the date of purchase).
- The products has been used in accordance to the conditions stated in the user manual and has been used in applications for which the products was intended by JS pumps.
- All modifications and repairs have been carried out by JS pumps or a certified JS pumps' dealer.
- That the pumps have been serviced and repaired with genuine JS pumps' spare parts.

The JS Pumps warranty does not cover faults which can be retraced to lack of maintenance, wrong installation, inadequate repairs or faults which are to be considered normal wear and tear of parts.

JS Pumps cannot be held responsible for physical damage to persons, material or economic damages in whatever form or size.

Introduction:

Thank you for choosing our RS, JS, SV, S, SK and S(U)S / SKSS series submersible pumps for dewatering purposes.

All safety requirements and specific manufacturer's requirements must be fulfilled before the product is put into operation. This operating and maintenance manual supplements any existing national regulations on industrial safety and accident prevention. This manual must also be accessible to personnel at all times and also be made available where the product is used.

This manual will instruct you on the general usage of this product and will provide details and precautions, in order for you to be able to use this pump under a secure and safe conditions.

To be able to use this product to its fullest capacity and performance it is of utmost importance to read this manual carefully. In case of defects or accidents, JS pumps and its distributors cannot be held responsible for any damages. We advise you to keep this manual with the pump unit, so that it can be consulted in case of doubt on the usage.

In case this product is to be rented to a third party, please kindly ensure that this manual is supplied together with the product and that the user has read this manual before putting this product into operation. Should this manual be lost or destroyed, please kindly contact your nearest JS Pump distributor, who will be able to supply you a back-up copy of the manual.

This manual has been prepared with care, however should you find any discrepancies or mistakes in the manual or have any questions regarding the operation of the product, please kindly contact your nearest JS Pump dealer immediately.

All personnel involved with the operation, servicing, inspection and installation of the equipment must be suitably qualified for this work and must have studied the instruction manual in depth to ensure that they are sufficiently conversant with its contents. The supervision, competence and areas of responsibility of the personnel must be precisely regulated by the operator. If the personnel do not have the necessary skills, they must be instructed and trained accordingly.

Contents:

BEFORE USE	7
Inspection of product	
Inspection of specification	
Product specification	
INSTALLATION	9
Preparation before installing the unit	
Pre-inspection	
Safety during installation	
ELECTRICAL INSTALLATION	14
Electrical wiring	
Grounding	
Power cord	
Connection power cord	
Wiring diagram	
PUTTING UNIT INTO OPERATION	16
Test run	
Thermal protection	
Water level during operation	
MAINTENANCE & INSPECTION	20
Periodic inspection	
Storage of pump	
Oil level check and oil change Maintenance	
CE declaration	22
Model specifications	23

Sound pressure:



Ear protection must be worn if the sound pressure is greater than 80dB (A).

The operator is responsible for ensuring compliance with these regulations!

The products produce a sound pressure of approximately 70dB (A) to 110dB (A). The actual sound pressure, however, depends on several factors.

These include, for example, the installation type (wet, dry, transportable), fastening of accessories (e.g. suspension unit) and pipeline, operating point, immersion depth, etc.

Once the product has been installed, we recommend that the operator make an additional measurement under all operating conditions.

Before use:

Please check the following after receipt of the unit:

- **Inspection of unit**

Remove the packaging and ensure that the unit did not incur any transport damage and that all bolts and nuts have remained tight during transport. Also ensure that all standard accessories have been received together with the unit.

- **Specification inspection**

Check the nameplate to ensure that the unit received is the same model as you ordered. Specifically check the voltage and frequency mentioned on the nameplate. Make sure that all safety guards are in place and secure.

Note: In case of transport damage or specification discrepancies, please contact your nearest JS Pump dealer.

- **Product specification**



Do not use the pump in any other application or condition than specified in this manual. Should you do so, you may risk electrical shocks, fire or the incorrect usage of the pump.

- If you need to work on the pump, make sure that it is isolated from the power supply and cannot be energized.
- Make sure that the pump cannot roll or fall over and injure people or damage property.
- In some installations, the pump and the surrounding liquid may be hot. Bear in mind the risk of burn injuries.
- Make sure nobody is close to the pump when it is started. The pump will jerk in the opposite direction of the impeller rotation.

Transportation

The Machine shall be moved by qualified persons only. Unauthorized personnel are not allowed to stay in the working place during transportation of the machine.

1. Please refer to the Manual Book for specifications and each package weight to arrange transportation and rigging.
2. Transportation, loading/unloading, handling and rigging shall be carried out by qualified personnel only.
3. Both overhead hoist and forklifts can be used when loading/unloading, and shall be operated by qualified personnel only.
4. Before handling, make sure all movable parts are secured in their positions, and all removable accessories should be removed from machine.
5. During loading/unloading, handling and positioning on site, the path and space for the machine shall remain clear and free of unqualified personnel.
6. PAY CLOSE ATTENTION to the machine balance when lifting it up from the floor.
7. Please refer to the picture shown to the right to find the correct forklift position for lifting up the machine.



Checklist before use:

- Ground all machines.
- A terminal for the connection of the external ground conductor must be provided in the vicinity of the associated phase conductor terminals with marked "PE". Make sure the "PE" terminal is connected before any power supplied to the machine.
- Supply voltage and source frequency: 0.94 - 1.1 times the nominal supply voltage and 0.99-1.01 nominal frequency. Verify the main power is stable before connecting it to the equipment. If not, use a voltage regulator.
- Ambient temperature: 5°C – 40°C.
- Altitude: shall be at altitudes up to 1000m above mean sea level.
- Relative humidity: not exceed 50% at 40°C.
- Electrical equipment shall withstand the effects of transportation and storage temperature within a range of -25°C to 55°C and for short periods not exceeding 24 hours at up to +70°C.
- Atmosphere: Free from excessive dust, acid fumes, corrosive gases and salt.
- The power supply should be away from humidity and properly grounded.
- Avoid exposing to direct sunlight or heat rays which can change the environmental temp.
- Avoid exposing to abnormal vibration.
- Electrical connection shall be installed by a professional electrician.

Installation

CAUTION

- JS, SV, S, SK and RS series submersible pumps are not explosion-proof. They are not designed to pump volatile or flammable liquids.
- The voltage may vary a maximum of $\pm 5\%$ of the nominal voltage mentioned on the nameplate.
- The pump can only be used in an environment with a temperature of 5° and 40°C.
- The pump must not be used when people are in the water.
- The pump must be supplied through a residual current device (RCD) having a rated residual operating current not exceeding 30mA. Disconnect the pump from the supply mains before carrying out user maintenance.
- The pump can only be used for pumping water. Do not use for pumping liquids such as oil, sea-water or organic solvents. For the AISI316 series, consult chemical resistance chart for compatibility between pump material and liquid before operating pump.
- Do not run the pump in explosive or fire hazardous surroundings or for pumping explosive liquids.
- Do not run the pump when the pump is partially or completely dismantled.

NOTE

Should you wish to deploy this pump unit in special conditions or special applications, please consult your nearest JS Pump dealer first.

⇒ Preparation before installing the unit.

Below you will find pictures of tools that you will require to install the pump correctly.

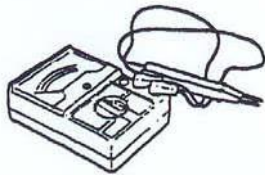

**AC Voltmeter
(tester)**

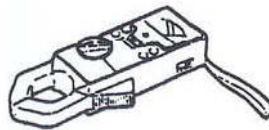

AC Amperemeter

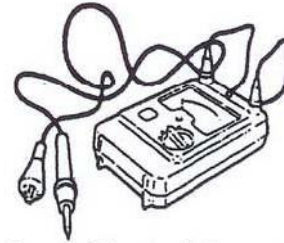

**Insulation resistancemeter
(megger)**

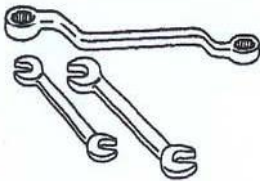

Spanners

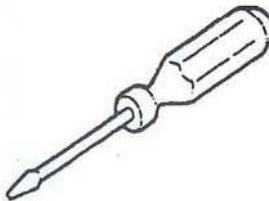

Screwdriver

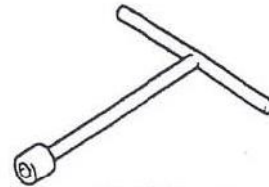

wheel brace

Before using the above tools, please ensure that you have studied their respective manuals to ensure correct usage of these tools.

⇒ Pre-inspection

Use the megger to measure the insulation resistance between the motor windings and between the motor windings and earth of the unit.

* Reference value of resistance > 20MΩ.



NOTE

The reference no. of 20MΩ min. is based on a new or recently refurbished pump unit.

⇒ Safety during installation

(1) Place the hose on the hose tail as deep as possible and tighten it with 1 or more hose bands.

Instructions regarding accident prevention.

Before commencing servicing or maintenance works, cordon off the working area and check that the lifting gear is in perfect condition.

Never work alone. Always wear a hard hat, safety glasses and safety shoes and, if necessary, a suitable safety belt.

Before carrying out welding works or using electrical devices, check to ensure there is no danger of explosion.

People working in wastewater systems must be vaccinated against the pathogens that may be found there. For the sake of your health, be sure to pay meticulous attention to cleanliness wherever you are working.

Make sure that there are no toxic gases in the working area.

Observe the relevant occupational health and safety regulations and keep first aid materials available.

In some cases, the pump and the pumping medium may be hot and could cause burns.

For installations in areas subject to explosion hazards, special regulations apply!

This device is not intended to be used by persons (including children) with limited physical, sensory or mental faculties or who are inexperienced and/or uninformed, unless they are supervised by a person responsible for their safety or have been instructed in the use of the device.

Children must be supervised to ensure that they do NOT come near or touch the device.



CAUTION

During transport, test-running, installation and handling of the pump, the unit should always be placed on a solid and flat surface, in order to prevent the pump from falling over.

The fastening devices should be kept safely and must be suitable for the conditions of use (weather, hooking system, load, etc.).

- Mobile working apparatus for lifting loads should be used in a manner that ensures their support stability during operation.

- When using mobile working apparatus for lifting nonguided loads, preventive measures should be taken to avoid tipping and sliding etc.
- Measures should be taken to ensure that no person is ever directly beneath a suspended load. Furthermore, it is also prohibited to move suspended loads over workplaces where people are present.
- If a mobile working apparatus is used for lifting loads, a second person should be present to coordinate the procedure, if required (for example, if the operator's field of vision is blocked).
- The load to be lifted must be transported in such a manner that nobody can be injured in the case of a power outage. Additionally, when working outdoors, such procedures must be interrupted immediately if weather conditions worsen.



Never lift or handle the pump by pulling the power cord, doing so, may result in a short circuit, electric shock or fire.



When handling the pump manually, please ensure that this is done with sufficient people, to ensure a correct division of weight per person. To avoid any possible damage to your health, we advise you to bend your knees and keep your back straight when lifting heavy weights. The pump must always be lifted by the handle and never by the power supply cable! The pump should only be lowered into deeper chambers or pits using a rope or chain.

(2) Handle the pump with care, do not drop or expose the unit to shocks. When lifting or lowering the pump, attach proper lifting equipment to the lifting handle (or lifting rings) fitted to the pump. Never lift or lower the unit by its power cord

Three phase pumps must be connected to a control box with a motor protection relay

External Protection Devices

The following protective devices should be fitted in the motor control panel:

- Short-circuit protection is accomplished by means of fuses, circuit breakers or electronic motor protectors. Fuses and circuit breakers should be specified to withstand the motor starting current, but the rating must not exceed that of the supply cable or switchgear. Where fuses are used, these should be of the motor rated type.
- Overload protection is required in a sudden overload situation, such as when the impeller develops operational difficulties or gets jammed, when the pump becomes clogged or during loss of phase in the mains supply. Overload protection is frequently provided by overload relays coupled to the motor contactors. These consist of ambient temperature-compensated bimetal elements, that trip the current to the contactor coils in case the current exceeds the set specified value. Overload relays



provide good protection against loss of phase in the supply. The overload relay should be set according to the motor nominal current.

When star delta start is used, the current through the overload relay is reduced by the factor 0,58 (1/3), which must be taken into account when setting the relay.



Do not run pump dry. Doing so will result in damaging the pump and possibly a short circuit and/or electric shocks. Hoses, pipes and valves should be measured correctly according to the specification of the pump. Incorrectly sized accessories could lead to leakage and malfunctioning of the pump.

(3) Ensure that you only install the pump in places where there is a sufficient water level.

(4) When installing the pump to fitted pipes, ensure the following conditions are met.

The discharge pipe should be as short as possible with a minimum of bends. Ensure that the discharge of the pipe has a free outflow. Should the discharge end of the pipe be submerged, there is a possibility that when the pump is stopped the water will flow backwards toward the pump. If the discharge is lower than the pump unit, there is a possibility that the water will continue to flow, even when the pump has been turned off.

Users will need to prepare their own pipes or hoses. Pipes and hoses are not standard accessories delivered together with this pump.

PVC pipe or rigid hose recommended. Collapsible vinyl hose will work but not as efficiently.



When pumping liquids with a high content of solids, this could lead to excessive wear and tear. This in turn could lead to leakage and electric shocks.

(5) The pump should be used in an upright position. If the danger exists that the pump will dig itself into the ground, sufficient support for the pump should be installed. Place on a solid surface or suspend the pump with a lifting rope/chain, taking precautions to avoid the pump rotating excessively.

Provide a suitable barrier around the work area, for example, a guard rail.

Electrical installation:

⇒ Electrical wiring



Electrical installations should be carried out under the supervision of a certified electrical engineer and according to the local rules and regulations. Installations prepared by a non-certified person, may be against the law, can be very dangerous and could invalidate any possible claims for warranty.

Incorrect installed wiring may lead to power leakage, electric shocks and can be a fire hazard.

All electrical equipment should be properly earthed. This accounts for both the pump and any possible control equipment.

Ensure that the power source is of sufficient capacity and that the cabling is of sufficient thickness.

⇒ Grounding



To avoid damage to the pump and any power leakage, which could result in electric shocks, please ensure that the grounding has been properly installed and checked.



To avoid electric shocks by improper grounding, please do NOT connect the earth wire to gas- or water pipes or telephone lines.

⇒ Power Cord



Please do not extend the power cord, unless this extension is carried out by a certified JS Pump distributor.

If the power cord has been damaged or cut, water may enter the cable, leading to possible damage to the pump, electric shocks or fire.

Please refrain from driving over the cable, to avoid any possible damage.



Never submerge the end of the cable under water.

To prevent the cable from damage, do not excessively bend the cable leading to the power source. Also do not lead the cable past sharp edges, as these may cut into the cable.

⇒ **Connecting power cable**



Before connecting the cable, ensure that the power to the control panel or thermal protection unit has been switched off. Disregarding this caution may lead to electric shocks, short circuits and / or injury due to a sudden start-up of the pump.

External Protection Devices (control panel)

The following protective devices are mounted in the motor control panel:

- Over current protection is accomplished by means of fuses, circuit breakers or electronic motor protectors. Fuses and circuit breakers should be correctly sized to withstand the motor starting current, but the rating must not exceed that of the supply cable. Where fuses are used, these should be of the motor rated type.
- Overload protection is required in a sudden overload situation, such as when the impeller develops operational difficulties or gets jammed, when the pump becomes clogged or during loss of phase in the mains supply. Overload protection is frequently provided by overload relays coupled to the motor contactors.

These consist of ambient temperature-compensated bimetal elements, that trip the current to the contactor coils in case the current exceeds the set specified value.

- Residual current device (RCD)

The pump is to be supplied through a residual current device (RCD) having a rated residual operating current not exceeding 30mA.

- (1) Securely connect the cable to the mounting points in the control panel or motor protection.
- (2) The figure on the right shows the correct fitting of the cable to the mounting points.

When three phase units are being commissioned for the first time and also when used on a new site, the direction of rotation must be carefully checked by a qualified person

When checking the direction of rotation, the unit should be secured in such a manner that no danger to personnel is caused by the rotating impeller, or by the resulting air flow. Do not place your hand into the hydraulic system. To do so will cause severe personal injury.

The direction of rotation should only be altered by a qualified person.

⇒ **Wiring diagram**

Direct online starting method

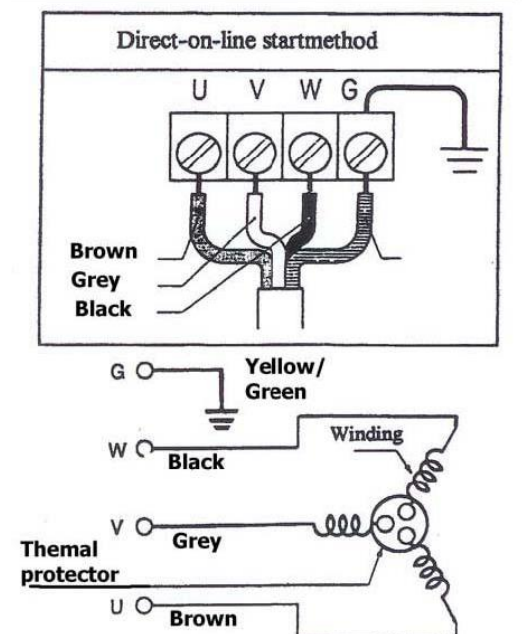

Putting unit in operation:



Incorrect voltage, frequency of the power source can lead to incorrect functioning of the pump, even power leakage or prove to be a fire hazard.

- (1) Re-check the nameplate for the correct voltage and frequency
- (2) Check the wiring, power source and the capacity of the earth leakage protector and the insulation resistance of the motor
 - * Reference value of resistance > 20MΩ.



Checking the insulation resistance

To check the insulation resistance, the power supply cable must be disconnected. The resistance can then be measured with an insulation tester. The following values may not be exceeded:

- For the initial start-up: Minimum insulation resistance 20 MΩ.
- For further measurements: Value must be greater than 2 MΩ.

If the insulation resistance is too low, moisture may have penetrated the cable and/or the motor. Do not connect the machine, consult manufacturer

- (3) Set the thermal protector to the nominal current value, as mentioned on the nameplate of the pump.
- (4) When used with a generator, limit the number of appliances used on the generator at the same time.

When operating the product, always follow the locally applicable laws and regulations for work safety, accident prevention and handling electrical machinery. To help to ensure safe working practice, the responsibilities of employees should be clearly set out by the owner. All personnel are responsible for ensuring that regulations are observed.

Certain parts (such as the rotor and impeller) rotate during operation in order to pump the fluid. Certain materials can cause very sharp edges to form on these parts.

⇒ Test run



Never run the pump when hanging from a chain or cable, where the starting torque may cause the pump to move and cause injury.

Never start the pump in the vicinity of people, who run the risk of electric shocks, due to power leakage.

- (1) Let the pump run for a short period (1 or 2 seconds) and check for correct direction of rotation.

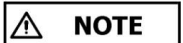

When using a phase indicator, please consult the manual of the unit before usage.

⚠ CAUTION

Before switching the phase to change the direction of the rotation of the pump, ensure that the pump is isolated from the mains and that the impeller is stopped. Failure to do so may result in serious consequences, such as short circuits, electric shocks and personal injury.

The direction of rotation should only be altered by a qualified person.

⇒ **To change the rotational direction of the pump, please do the following.**

CHANGE 2 OF THE 3 PHASE WIRES DESIGNATED WITH U, V OR W

(2) Run the pump for a short period (3 – 10 minutes) and check the following:

(3)

If the direction of rotation is incorrect then this is altered by changing over two phases of the power supply cable in the control panel. The direction of rotation should then be rechecked.

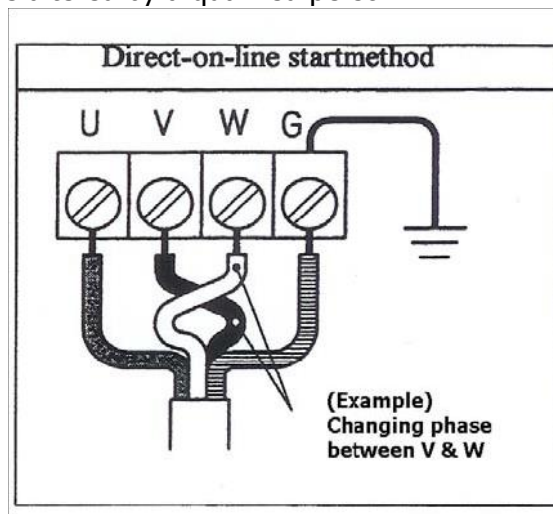

• **Used current**

Use an ampere meter and measure the current on each separate phase-wires U, V, W, which are connected to the control panel or motor-protection switch.

Overloading the motor could be a result of a too high amperage, which exceeds the nominal current. Please check the specifications to adjust the thermal overload protection.

• **Voltage**

Use an AC voltmeter to check the voltage on the control panel or motor-protection switch.

• **Tolerance for the voltage is $\pm 5\%$ of the voltage as mentioned on the nameplate of the pump.**

If the voltage is outside of the tolerance, the power source may be too small for the pump or the power cable may be too long.

• **Vibrations**

⚠ CAUTION

If the pump vibrates or emits noise and/or smells, immediately turn off the power and contact your nearest JS Pump dealer.

Only operate the pump, when no abnormalities have been detected during testing.



The pump can become very hot during operation. To avoid burns, do not touch the pump with bare hands.

Never insert body parts in the inlet of the pump. It could cause severe injury, electric shocks, short circuit or fire.

When the pump is not used for a prolonged period of time, ensure that the current is switched off from the power source. Aging may cause a reduced insulation of the power cable and cores. If connected with power, this may lead to power leakage, electric shocks and fire.

Carefully check the water level during operation of the pump. The pump may be damaged when running dry.

⇒ **Thermal protection**

The pump is equipped with an internal thermal protector (Thermal protector in a star point winding)



Ensure that the pump is isolated from the mains during inspection and repair, so that the unit cannot be started by accident. In case of neglect, this could lead to serious injury, electric shocks or fire.

During a power outage, please disconnect the pump from the mains. Unexpected startup of the pump after the power has been restored can be very dangerous for people in the direct neighborhood of the pump.



If the pump encounters or develops a fault, the pump may switch on and off on its motor-protection. The inbuilt thermal overload is not a guarantee of protection and repeated activation can cause weakness or failure of the thermal protector, resulting in damage to the pump. It is therefore advised to immediately check and resolve problems when the pump switches itself off.

Do not run the pump with a clogged inlet. This will cause the pump to overload and could lead to vibrations and noise. This situation could cause damage to the pump, electric shocks and fire.

To protect the motor from overload or overheating, the protector will cause the pump to stop, irrespective of the water level.

⇒ **Water level during operation.**



Never run the pump with a lower water level than the allowed minimum water level (M. W. L.).

The MWL is specific to each model. Please check before use.

Neglect could lead to damage of the pump, power leakage and electric shocks.

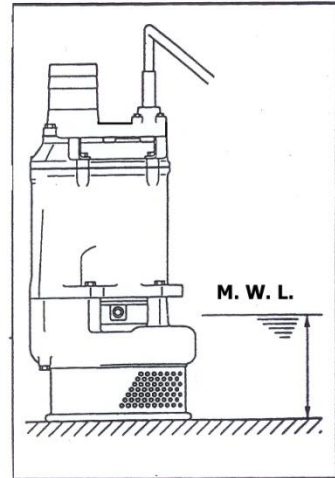

Maintenance and inspection:

It is of the utmost importance to provide regular maintenance and service to ensure a correct operation of the pump. Please contact your nearest JS Pump dealer to provide details on service and parts.

⇒ Periodic Check



Ensure that the pump has been disconnected from the power source before attempting any maintenance or checks. Negligence could have serious consequences, such as electric shocks and personal injury due to unexpected startup of the pump.

(1) Cleaning the pump

Remove all dirt from the outer casing of the pump and clean the pump with clean water. Particular attention should be given to the pump inlet, strainer and impeller and remove all dirt and solids in these areas.

(2) Inspection of pump surface

Check the coating of the pump for serious damage or whether any other damages can be detected. Check whether all bolts and nuts are still tightened sufficiently. Should the coating be seriously damaged, let the pump dry and repair the damages.

The coating of the pump should be provided by the user themselves. Should the pump need to be disassembled in order to repair or rework damages, please contact your nearest JS Pump dealer.

⇒ Periodic maintenance

Monthly:

- Check Insulation values with megger
- Measure input current
- Check voltage
- Inspect impeller

Half-year:

- Check and change oil in oil chamber

Yearly:

- Change oil and replace mechanical seal

Once in 2-5 years:

- Complete overhaul (even when pump is functioning correctly)

⇒ Storage of pump

When the pump is to be stored for a prolonged period, lift the pump from the water. Ensure the pump is clean, dry and clear debris from pump chamber if present, then store in a dry area.

When the pump is to be put into operation after a prolonged period of storage, please test the pump, as indicated in this manual, before putting into operation again.

When the pump is stored under water, perform regular tests (once a week) to avoid the impeller rusting against the casing.

⇒ Oil check and oil change

- Check interval : every 3000 hrs. or after 6 months (whichever comes first)
- Change interval : every 6000 hrs. or after 12 months (whichever comes first)

⇒ Oil Check

Remove the oil plug and drain a small quantity of oil by tipping the pump over. If the oil is discoloured or is mixed with water, the mechanical seal has probably been damaged and will need to be changed.

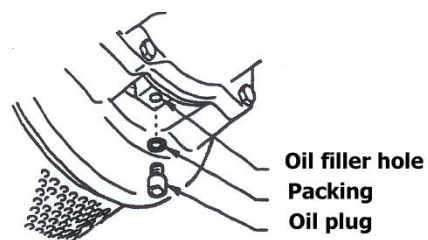

⇒ Oil change

Remove the oil plug and drain the oil completely from the chamber. Refill the chamber with the correct type of oil.

EU Declaration of Conformity



For the following equipment:

Product: Submersible Pump
Type designation: RS-, RST-, JS-, JST-, GS, GST-,
Puddle Buddy (RSD-series)

Manufacturers name: Joung Shin Electric Corp.

Manufacturers Address: No. 83-9 Dapiantou
Sanzhi District
New Taipei City 252
Taiwan, R.O.C.

Herewith confirms to comply with the requirements set out in the council directives:

2006/42/EC, 2006/95/EC, 2004/108/EC

On the approximation of the laws of the member states relating to the electromagnetic compatibility

For the evaluation of the compliance with these directives the following harmonized standards were applied:

EN809	EN60335-1	EN60335-2-41	EN61000-6-3
EN61000-6-1	EN55014	EN60555	

Responsible for making this declaration is the authorised representative within the EU:

Company Name: W. Robinson & Sons (EC) Ltd.
Company Address: Hainault Business Park
35-41 Fowler Road
Ilford, Essex IG6 3WR
United Kingdom

Name, Surname: G.W. Robinson
Position: Director
Date: Ilford, Essex 28/12/2012

Company Stamp and authorised signature:

W. Robinson & Sons (EC) Ltd.
Hainault Business Park
35-41 Fowler Road
Ilford, Essex IG6 3WR
United Kingdom

Model specifications:

JS drainer series

Pump Type	Output KW	Output HP	Discharge Inch	Voltage	Max			Cable M	Weight kg
					Head M	Capacity L/min	Solids mm		
JS100	0.1	0.14	1	1 phase 110V-240V	6	90	4	10	5
JS150	0.15	0.2	1¼		7	110	4	10	5.5
JS250	0.25	0.34	1½		9	200	6	10	9
JS400	0.4	0.5	2		11	250	6	10	10
JS750	0.75	1	2		15	450	6	10	24
JS1500	1.5	2	3		19	680	6	10	49
JS1500H	1.5	2	2		23	560	6	10	49
JS530	1.3	1.5	1”		45	140	1	10	17

Pump Type	Output KW	Output HP	Discharge Inch	Voltage	Max			Cable M	Weight kg
					Head M	Capacity L/min	Solids mm		
JST8	0.75	1	2	3 phase 200V-600V	15	450	6	10	21
JST15	1.5	2	3		19	680	6	10	26
JST15H	1.5	2	2		22	560	6	10	26
JST22	2.2	3	3		20	1100	10	10	39
JST22H	2.2	3	2		26	920	10	10	39
JST37	3.7	5	3 or 4		24	1200	10	10	45
JST37H	3.7	5	2		31	1000	10	10	45
JST55	5.5	7.5	4		25	1700	10	10	65
JST55H	5.5	7.5	3		36	1350	10	10	65
JST75	7.5	10	6		34	2000	10	10	75
JST75H	7.5	10	4		40	1500	10	10	75
JST110	11	15	6		43	2300	10	10	85
JST110H	11	15	6		60	1400	10	10	85
JST150	15	20	6		46	2750	10	10	167
JST220	22	30	6		60	2800	10	10	183

RS drainer series

Pump Type	Output KW	Output HP	Discharge Inch	Voltage	Max			Cable M	Weight kg
					Head M	Capacity L/min	Solids mm		
RS100	0.1	0.14	1	1 phase 100V-240V	6	90	4	10	4.1
RS150	0.15	0.2	1¼		7	140	4	10	5.5
RS250	0.25	0.34	1½		8	175	6	10	13
RS400	0.4	0.5	2		11	220	6	10	14
RS550-2	0.55	0.74	2		12	400	6	10	25
RS750-2	0.75	1	2		13	460	6	10	25
RS1500	1.5	2	2		21	580	6	10	26
RS1500H	1.5	2	2		24	520	6	10	26

Pump Type	Output KW	Output HP	Discharge Inch	Voltage	Max			Cable M	Weight kg
					Head M	Capacity L/min	Solids mm		
RST6-2	0.55	0.74	2	3 phase 200V-600V	12	400	6	10	25
RST8-2	0.75	1	2		13	460	6	10	24
RST15	1.5	2	2		21	580	6	10	26
RST15H	1.5	2	2		24	520	6	10	26
RST22	2.2	3	3		20	980	10	10	50
RST22H	2.2	3	3		24	900	10	10	50
RST37	3.7	5	3		24	1200	10	10	55
RST37H	3.7	5	3		30	1200	10	10	55
RST55	5.5	7.5	4		27	1200	10	10	70
RST55H	5.5	7.5	3		39	1200	10	10	70
RST75	7.5	10	4		32	1600	10	10	75
RST75H	7.5	10	4		43	1200	10	10	75

JS AISI316 drainer series

Pump Type	Output KW	Output HP	Discharge Inch	Voltage	Max			Cable M	Weight kg
					Head M	Capacity L/min	Solids mm		
JS250SS	0.25	0.34	1½	1 phase 100V-240V	9	200	6	10	9
JS400SS	0.4	0.5	2		11	250	6	10	10
JS750SS	0.75	1	2		15	450	6	10	24
JS1500SS	1.5	2	3		19	680	6	10	49
JS1500HSS	1.5	2	2		23	560	6	10	49

Pump Type	Output KW	Output HP	Discharge Inch	Voltage	Max			Cable M	Weight kg
					Head M	Capacity L/min	Solids mm		
JST8SS	0.75	1	2	3 phase 200V-600V	15	450	6	10	21
JST15SS	1.5	2	3		19	680	6	10	26
JST15HSS	1.5	2	2		22	560	6	10	26
JST22SS	2.2	3	3		20	1100	10	10	39
JST22HSS	2.2	3	2		26	920	10	10	39
JST37SS	3.7	5	3 or 4		24	1200	10	10	45
JST37HSS	3.7	5	2		31	1000	10	10	45
JST55SS	5.5	7.5	4		25	1700	10	10	65
JST55HSS	5.5	7.5	3		36	1350	10	10	65
JST75SS	7.5	10	6		34	2000	10	10	75
JST75HSS	7.5	10	4		40	1500	10	10	75
JST110SS	11	15	6		43	2300	10	10	85
JST110HSS	11	15	6		60	1400	10	10	85
JST150SS	15	20	6		46	2750	10	10	167
JST220SS	22	30	6		60	2800	10	10	183

SV sewage vortex series

Pump Type	Output KW	Output HP	Discharge Inch	Voltage	Max			Cable M	Weight kg
					Head M	Capacity L/min	Solids mm		
JS100SV	0.1	0.14	1¼	1 phase 100V-240V	4	82	25	10	5
JS150SV	0.15	0.2	1¼		7	140	25	10	5.5
JS250SV	0.25	0.34	1½		7	178	35	10	9
JS400SV	0.4	0.5	2		8.5	270	35	10	8
JS750SV-3	0.75	1	2		12	480	35	10	16
JS750SV	0.75	1	3		8.5	600	46	10	19
JS1500SV	1.5	2	3		12	840	46	10	24
JS1500SV	1.5	2	3		9	900	65	10	24

Pump Type	Output KW	Output HP	Discharge Inch	Voltage	Max			Cable M	Weight kg
					Head M	Capacity L/min	Solids mm		
JST4SV	0.4	0.5	2	3 phase 200V-600V	8.5	270	35	10	8
JST8SV-3	0.75	1	2		12	480	35	10	16
JST8SV	0.75	1	3		8.5	600	46	10	19
JST15SV	1.5	2	3		12	840	46	10	24
JST15SV	1.5	2	3		9	900	65	10	24
JST22SV	2.2	3	3		17	1060	57	10	51
JST37SV	3.7	5	3		23	1400	57	10	55
JST37SV	3.7	5	3		12	1300	80	10	55

Pump Type	Output KW	Output HP	Discharge Inch	Voltage	Max			Cable M	Weight kg
					Head M	Capacity L/min	Solids mm		
JST22SV4	2.2	3	3	3 phase 200V-600V	8	1400	80	10	52
JST55SV4	5.5	7.5	4		12	2600	100	10	75
JST75SV4	7.5	10	4		14	2620	100	10	80

S sewage single channel series

Pump Type	Output KW	Output HP	Discharge Inch	Voltage	Max			Cable M	Weight kg
					Head M	Capacity L/min	Solids mm		
JS750S	0.75	1	2	1 phase 100V-240V	15	370	21	10	27
JS1500S	1.5	2	3		18	920	44	10	38

Pump Type	Output KW	Output HP	Discharge Inch	Voltage	Max			Cable M	Weight kg
					Head M	Capacity L/min	Solids mm		
JST8S	0.75	1	2	3 phase 200V-600V	15	370	21	10	26
JST15S	1.5	2	3		18	920	44	10	35
JST22S	2.2	3	3		22	1100	44	10	43
JST37S	3.7	5	3 or 4		24	1600	35	10	47
JST55S	5.5	7.5	4		25	1900	55	10	79
JST75S	7.5	10	4 or 6		31	2200	55	10	85
JST110S	11	15	6		39	2300	55	10	94

Pump Type	Output KW	Output HP	Discharge Inch	Voltage	Max			Cable M	Weight kg
					Head M	Capacity L/min	Solids mm		
JST15S4	1.5	2	3	3 phase 200V-600V	12	1100	60	10	50
JST22S4	2.2	3	3		15	1200	60	10	53
JST37S4	3.7	5	3 or 4		16	1200	75	10	57

SK sewage shredder series

Pump Type	Output KW	Output HP	Discharge Inch	Voltage	Max			Cable M	Weight kg
					Head M	Capacity L/min	Solids mm		
JS750SK	0.75	1	2	1 phase 100V-240V	15	350	21	10	27
JS1500SK	1.5	2	3		18	1000	44	10	38

Pump Type	Output KW	Output HP	Discharge Inch	Voltage	Max			Cable M	Weight kg
					Head M	Capacity L/min	Solids mm		
JST8SK	0.75	1	2	3 phase 200V-600V	15	350	21	10	26
JST15SK	1.5	2	3		18	1000	44	10	35
JST22SK	2.2	3	3		21	1400	44	10	43
JST37SK	3.7	5	3 or 4		24	1500	35	10	47

Pump Type	Output KW	Output HP	Discharge Inch	Voltage	Max			Cable M	Weight kg
					Head M	Capacity L/min	Solids mm		
JST55SK4	5.5	7.5	4	3 phase 200V-600V	20	1970	60	10	140
JST75SK4	7.5	10	4 or 6		22	2800	60	10	150
JST110SK4	11	15	6		26	3400	50	10	220
JST150SK4	15	20	6		33	3500	55	10	235

SKSS sewage AISI316 shredder series

Pump Type	Output KW	Output HP	Discharge Inch	Voltage	Max			Cable M	Weight kg
					Head M	Capacity L/min	Solids mm		
JS750SKSS	0.75	1	2	1 phase 100V-240V				10	27
JS1500SKSS	1.5	2	3		18	1000	44	10	38

Pump Type	Output KW	Output HP	Discharge Inch	Voltage	Max			Cable M	Weight kg
					Head M	Capacity L/min	Solids mm		
JST8SKSS	0.75	1	2	3 phase 200V-600V	15	350	21	10	26
JST15SKSS	1.5	2	3		18	1000	44	10	35
JST22SKSS	2.2	3	3		21	1400	44	10	43
JST37SKSS	3.7	5	3 or 4		24	1500	35	10	47

Pump Type	Output KW	Output HP	Discharge Inch	Voltage	Max			Cable M	Weight kg
					Head M	Capacity L/min	Solids mm		
JST55SK4SS	5.5	7.5	4	3 phase 200V-600V	20	1970	60	10	140
JST75SK4SS	7.5	10	4 or 6		22	2800	60	10	150
JST110SK4SS	11	15	6		26	3400	50	10	220
JST150SK4SS	15	20	6		33	3500	55	10	235

GS sewage grinder series

Pump Type	Output KW	Output HP	Discharge Inch	Voltage	Max			Cable M	Weight kg
					Head M	Capacity L/min	Solids mm		
GS750	0.75	1	1¼	1 phase 100V-240V	15	180	3	10	25
GS1200	1.2	1.5	1¼		19	190	3	10	28
GS1500	1.5	2	1¼		23	190	3	10	31

Pump Type	Output KW	Output HP	Discharge Inch	Voltage	Max			Cable M	Weight kg
					Head M	Capacity L/min	Solids mm		
GST8	0.75	1	1¼	3 phase 200V-600V	15	180	3	10	26
GST12	1.2	1.5	1¼		19	190	3	10	29
GST15	1.5	2	1¼		23	190	3	10	32
GST22	2.2	3	2		24	320	3	10	45
GST37	3.7	5	2		37	330	3	10	47

