

Hunter®

 **Hydrawise™ Ready**
IRRIGATION CONTROLLERS

Hydrawise Software/App Owner's Manual



hydrawise.com

Table of Contents

| | |
|----------------------------------------------------------------------------------------|----|
| Table of Contents | 2 |
| Performing a Reboot or Factory Default at Controller | 4 |
| Can I use the controller if I don't have internet access? | 5 |
| Basic Screen Navigation & Offline Functions | 6 |
| Setting up a Controller in Offline Mode | 9 |
| Configuring the Offline Adjustments - Watering with No Internet | 11 |
| Viewing the Time and Date | 13 |
| Viewing the Controller Status | 14 |
| Server Status | 15 |
| Success | 16 |
| Offline | 17 |
| Saving Settings | 17 |
| Serial Number | 17 |
| Viewing the Serial Number | 17 |
| Viewing the Zone Information | 19 |
| Viewing Network Information / Testing Internet Connectivity / Connection Status | 21 |
| Viewing Network Information | 21 |
| Test Network | 22 |
| Checking Connection Status | 22 |
| Manual Operation from the Controller | 23 |
| Running a SINGLE zone manually from the controller | 24 |
| Running ALL ZONES manually from the controller | 25 |
| Controller has a Blank Display | 26 |
| Flow Meter Pressure Loss Chart | 27 |
| Flow Meter - Configuration | 27 |
| Flow Meter - Installation Quick Start Guide | 30 |
| The flow meter consists of two parts: | 30 |
| The following instructions assume you have already installed your Hydrawise controller | 31 |
| Use your Hydrawise account to complete your flow meter configuration. | 32 |
| Flow Meter - Installation Tips | 33 |
| Flow Meter - Specifications | 35 |
| Flow Meter - Reading Meter | 36 |
| Flow Meter - Testing Meter | 38 |
| Flow Meter - Custom Flow Sensor Configuration | 39 |
| Can I Use One Flow Meter for Two Controllers? | 41 |
| Flow Meter - Winterization | 42 |
| Wire Distance (Controller to Valve) | 44 |
| Pump Start Relay Wiring and Online Setup | 45 |
| Summary | 45 |
| Operation Chart | 46 |
| Wiring (24 VAC) | 46 |
| Wiring to Power Source | 47 |
| Online Setup | 48 |
| Pump Start Relay Operation per Station | 49 |
| One Master Valve - Two Controllers | 50 |
| Master Valve Wiring and Online Setup | 51 |
| Brief Summary | 51 |

| | |
|---------------------------------------------------------|----|
| Operation Chart | 51 |
| Wiring | 52 |
| Setup Online | 53 |
| Master Valve (P/MV) Operation per Station | 54 |
| Sprinklers Running with the Controller Off or Unplugged | 54 |

Performing a Reboot or Factory Default at Controller

In the event you are having issues connecting to your Wi-Fi network, it is a good idea to reboot and/or perform a factory default at the controller. Please follow the steps below to perform a reboot on your controller. This can help reestablish WiFi if you are having communication issues. The reboot will not erase any settings in your controller.

1. From the home screen, select **SETTINGS**.
2. Select **CONFIG**.
3. Select **REBOOT CONTROLLER**.

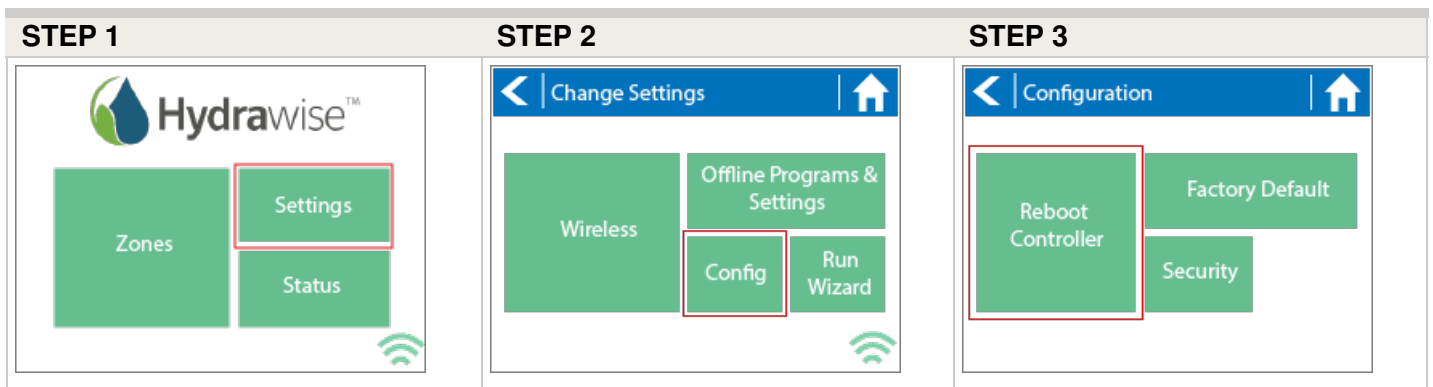

If the reboot procedure did not help with connection, please follow the steps below to perform a factory reset on your controller. When the controller goes back online, the settings in the software will sync back into the controller within seconds.

1. From the home screen, select **SETTINGS**.
2. Select **CONFIG**.
3. Select **FACTORY DEFAULT**.
4. Select **ERASE CONFIG**.

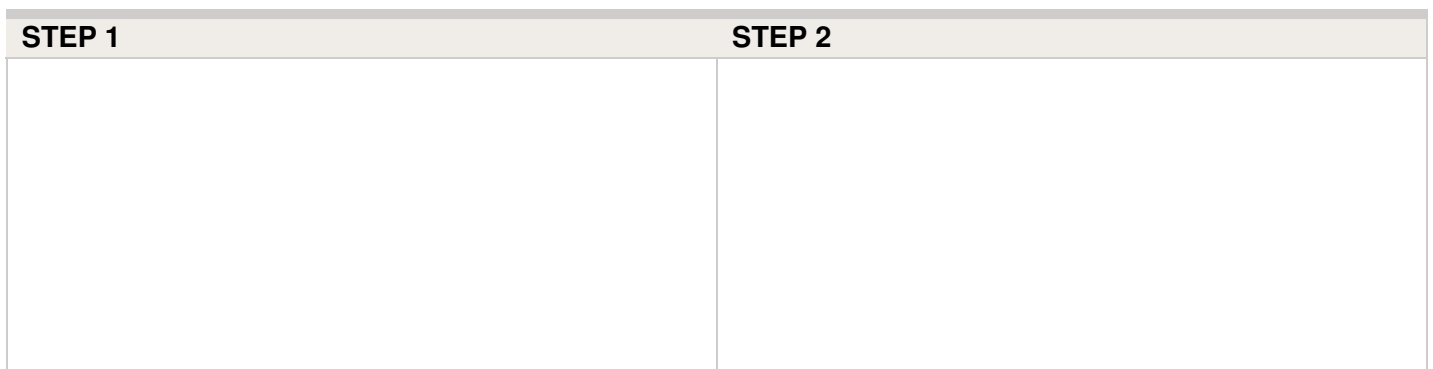

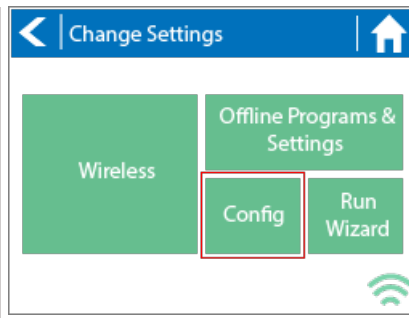

STEP 3

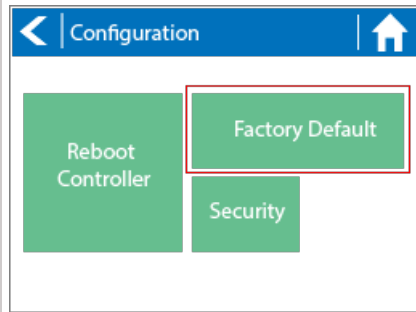

STEP 4

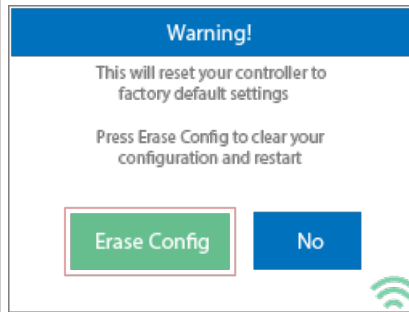

The controller is now ready for new configuration settings, either manually or automatically through synchronization with your Hydrawise account.

To link your controller to your account, refer to [How to Remove or Link your Serial Number](#)

[1].

Can I use the controller if I don't have internet access?

Yes! If you don't have internet access, you can configure the controller using the touch screen. Refer to the [Offline Setup Wizard](#) if you have questions about how to do this.

Internet connectivity, however, is required for advanced functions, such as automatic schedule modifications.

Basic Screen Navigation & Offline Functions

The controller features a full color touchscreen making navigation easy.

The Home screen, shown below, has 3 buttons allowing you to view and run your irrigation zones, change controller settings or view status information.

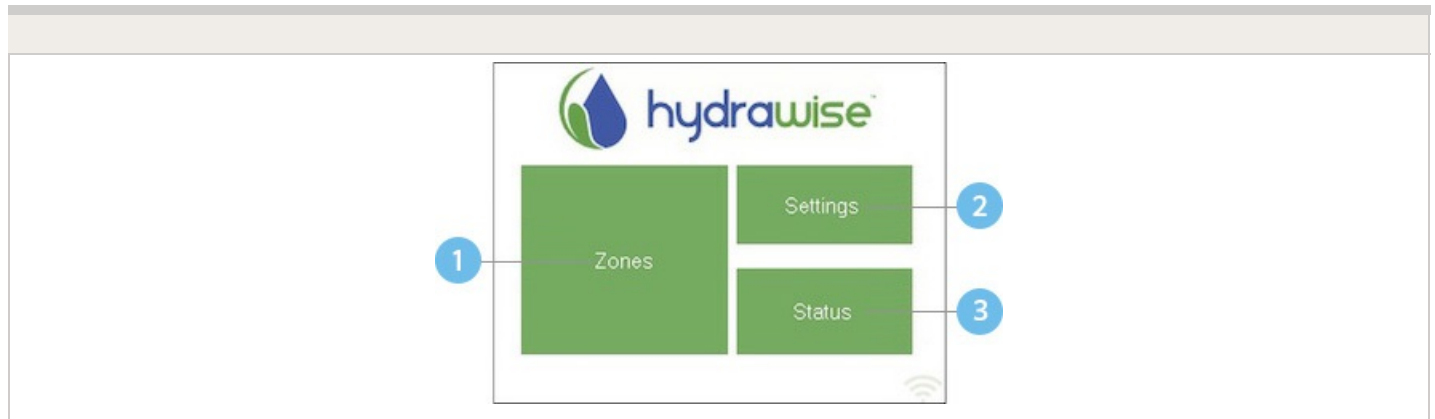

- 1 Touch to view all zones
- 2 Touch to change controller settings
- 3 Touch to view controller status information

Each screen (except for the home screen) has two buttons at the top of the page allow you to quickly navigate to the Home screen or the previous screen.

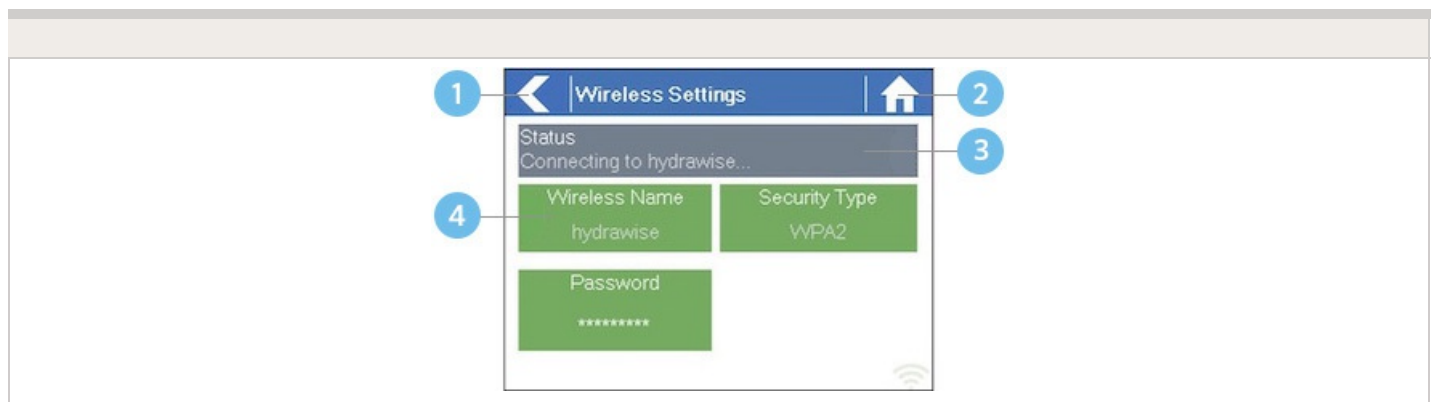

- 1 Go to previous screen (changes not saved)
- 2 Go to Home screen (changes not saved)
- 3 GREEN items indicate settings which can be changed
- 4 GREY items indicate status information

All items on each screen are color coded to indicate which screen elements are buttons and which screen elements indicate status information.

GREEN screen items indicate settings that can be changed. If you touch on the GREEN color item then you'll be able to change that setting.

GREY colored items indicate status information. Touching on these has no effect.

If you're entering information into the controller and use the Home or Back buttons then your changes on that screen will not be changed.

The charts below will walk you through the different function paths when programming at the controller with and without internet.

| OFFLINE STANDARD MODE | |
|-------------------------------------|----------------------------------------------------------------------------------------------------------------|
| Adjust Time: | Home > Settings > Offline Programs and Settings > Time |
| Enable Wi-Fi: | Home > Settings > Offline Programs and Settings > Enable Wi-Fi |
| Program Sensor/Check Status: | Home > Settings > Offline Programs and Settings > Sensors > Configure to level type for normally closed style. |
| Start Times: | Home > Settings > Offline Programs and Settings > Offline Programs > Edit Start Times |
| Water Days: | Home > Settings > Offline Programs and Settings > Offline Programs > Edit Water Days |
| Zones: | Home > Settings > Offline Programs and Settings > Offline Programs > Edit Zones |
| Master Valve: | Home > Zones > Zone > Click blue bar > Select Master Valve > Confirm |
| Set Seasonal Adjust: | Home > Settings > Offline Programs and Settings > Seasonal Adjust |

| OFFLINE ADVANCED MODE | |
|-----------------------|--------------------------------------------------------|
| Adjust Time: | Home > Settings > Offline Programs and Settings > Time |

| | |
|-------------------------------------|---------------------------------------------------------------------------------------|
| Enable Wi-Fi: | Home > Settings > Offline Programs and Settings > Enable Wi-Fi |
| Program Sensor/Check Status: | Home > Settings > Offline Programs and Settings > Sensors |
| Start Times: | Home > Settings > Offline Programs and Settings > Offline Programs > Edit Start Times |
| Water Days: | Home > Settings > Offline Programs and Settings > Offline Programs > Add or Modify |
| Zones: | Home > Zones > Choose Zone > Run Time > OK |
| Master Valve: | Home > Zones > Zone > Click blue bar > Select Master Valve > Confirm |
| Set Seasonal Adjust: | Home > Settings > Offline Programs and Settings > Seasonal Adjust |

ONLINE MODE

Change Wi-Fi/Check Status: Home>Settings>Wireless>Select a Setting to Modify

Controller Status: Home>Status>Controller Status

Program Expander: Home>Status>Expansion Modules

Manually Run Zone(s): Home>Zones>Select Zone> Run>Enter Time>OK

Model: Home>Status>Controller Status

Network Status: Home>Status>Network

Reboot Controller: Home>Settings>Config>Reboot Controller

Reset Controller: Home>Settings>Config>Factory Default

Run Wizard: Home>Settings>Run Wizard

Sensor Status: Home>Status>Sensor

Serial Number: Home>Status>Controller Status

Server Status: Home>Status>Controller Status

Test Network: Home>Status>Network>Test Network

Test Zone: Home>Status>Zone Tester

Time and Date: Home>Status>Time

Version Number: Home>Status>Controller Status

Zone Status: Home>Zones>Select Zone

Setting up a Controller in Offline Mode

Offline programming will allow your controller to run without any internet access like a traditional irrigation controller. You have two options to program your controller if you currently do not have WiFi access.

1. Using the App to Program controller with no WiFi
2. Offline programming at the controller

Using App to Program controller with no Wifi (e.g; new construction)

In some cases, it may not be convenient to program the controller using the offline mode feature (programming using controller screen). The following steps **must** be taken if programming the controller through the app with a hotspot.

1. Create Hotspot with Smartphone: Depending on your smartphone, please use either guide below:
 - **Apple hotspot** ^[4]
 - **Android hotspot** ^[5]
2. Once you activate your hotspot, connect the controller to verify the Wi-Fi on the controller is working properly.
3. Disable WIFI completely. *Settings > Offline Settings > Disable Wifi*
4. Remove hotspot and programming will remain in the controller.

Programming at Controller

Hydrawise has two different modes that will run in offline mode at the controller.

| Modes | Controller Models |
|---------------|--------------------------|
| Standard Mode | HPC, HCC, PRO-HC, and X2 |
| Advanced Mode | HPC, HCC, PRO-HC, and HC |

Standard offline programming will allow the controller to run like our traditional controllers the X-core and the Pro-C models. Each of the six programs (a-f) allows you to start each program up to four times a day, set run lengths and set specific days to water.

Advanced offline programming will allow the controller to run independently for each zone(station). Each zone (station) can have up to four start times with their individual run times.

To set your controller in **Offline Mode** for manual configuration, please follow the steps below:

1. From the main menu, tap on **SETTING**.
2. Select **CONFIG**.
3. Select **FACTORY DEFAULT**.
4. Next , press **ERASE CONFIG**. This will reset the controller back to factory settings. You will be presented with a warning dialogue.
5. Select **CONFIGURE OFFLINE** and follow the wizard steps.

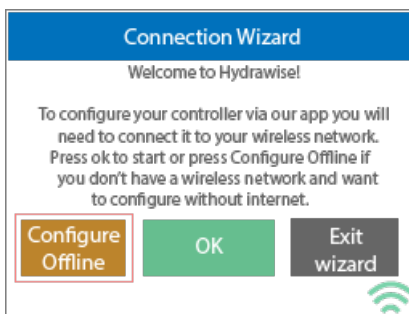

This wizard will guide you through the steps to set up your controller to run in offline mode without an internet connection.

If you choose to switch modes when using the compatible model, use the steps below:

1. From the main menu, tap on **SETTINGS**.
2. Select **OFFLINE PROGRAMS AND SETTINGS**.
3. Select **OFFLINE MODE**.
4. Choose mode and select **CONFIRM**.

If you decide to connect the controller via internet at a later date, the online programming will sync with controller within a few seconds and override the offline programming.

Configuring the Offline Adjustments - Watering with No Internet

If your controller loses internet connectivity for more than one day, we'll send you an email notification. During this time, your controller will run the last synced schedule in offline mode. The feature **OFFLINE ADJUSTMENTS** allows the controller to automatically adjust the amount of watering on a month by month basis if the controller is in an Offline mode (ie. not connected to the internet).

Steps below will cover both online and offline instructions on changing the seasonal adjust for when the controller enters offline mode.

Online: Offline Water Adjustment

1. Select **Controller Settings** on the left hand side.
2. Select **Offline Adjustments**.
3. Sliders can be moved to adjust the offline watering from 0%-300%.

STEP 1-2

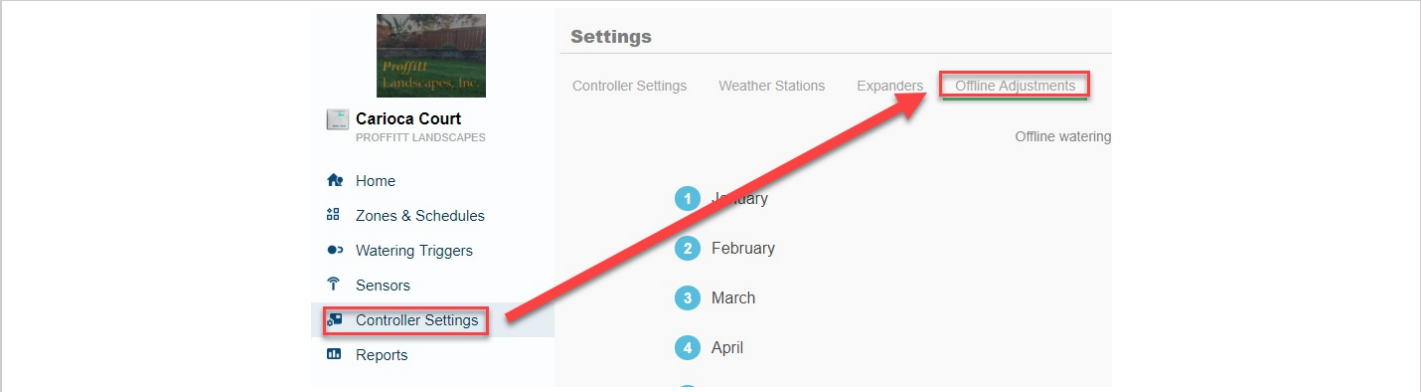

The screenshot displays the Profitt Landscapes web interface. On the left, a navigation menu for 'Carioca Court' includes options like Home, Zones & Schedules, Watering Triggers, Sensors, Controller Settings (highlighted with a red box), and Reports. The main content area shows the 'Settings' page with tabs for Controller Settings, Weather Stations, Expanders, and Offline Adjustments (highlighted with a red box). A red arrow points from the 'Controller Settings' menu item to the 'Offline Adjustments' tab. Below the tabs, a list of months is visible: 1 January, 2 February, 3 March, and 4 April.

STEP 3

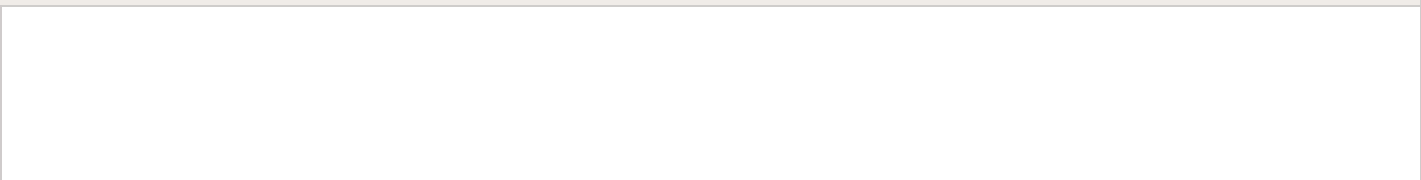

This section is currently blank, intended for the instructions corresponding to Step 3.

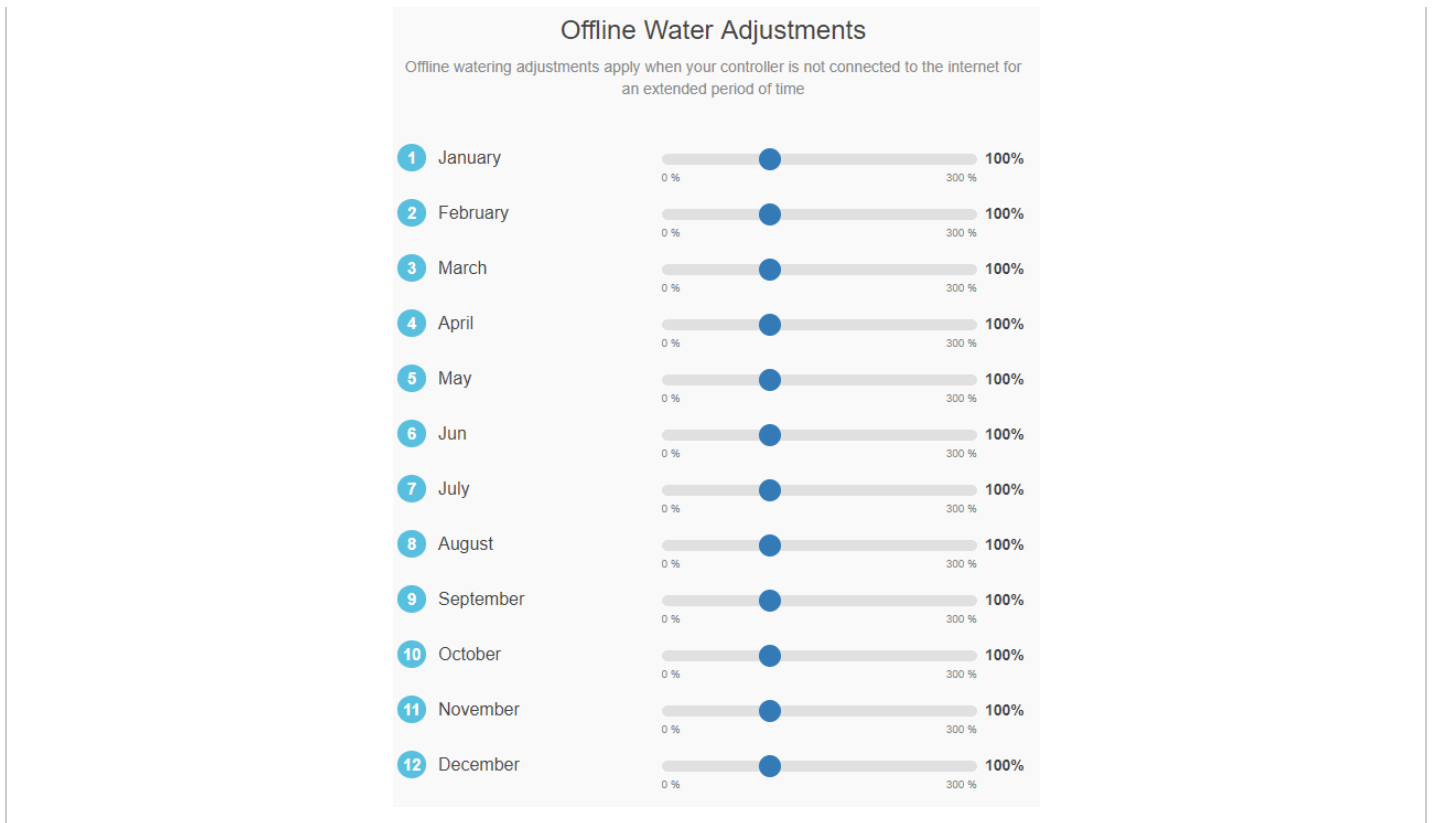

Offline: Offline Water Adjustment

1. Select settings.
2. Next, select offline settings.
3. Select seasonal adjust.
4. Select a month to adjust.
5. Adjust each month by a percentage then select OK.

CONTROLLER SCREENSHOTS:

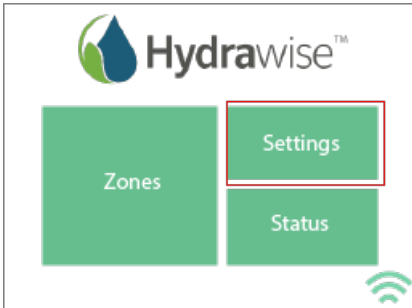
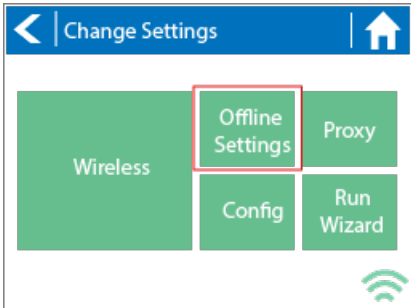

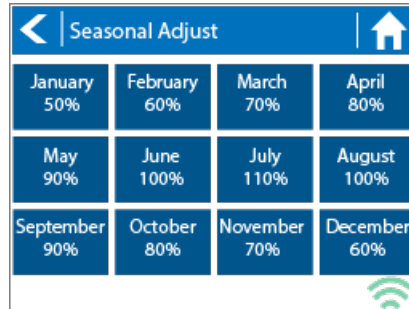
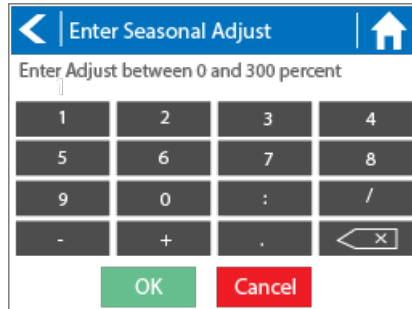
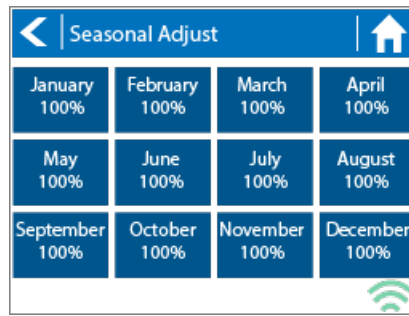
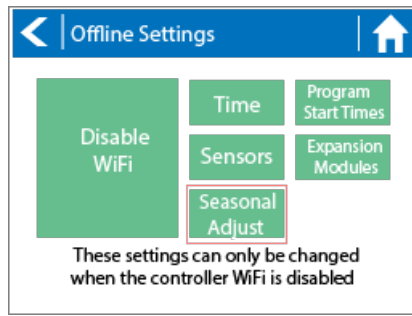



Viewing the Time and Date

Time and date settings are synchronized with the settings that you configure in the Hydrowise app. The timezone is set based on the location you entered during the app

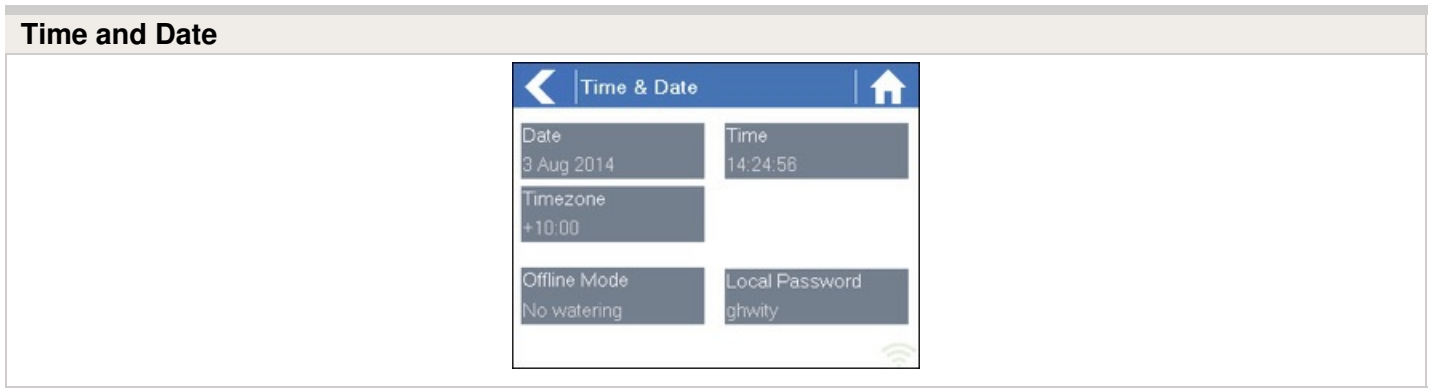
wizard.



If your controller is running as a stand-alone controller (WiFi is disabled) then the date, time and time zone will be shown on a GREEN background can be changed.

Viewing the Controller Status

From the Home screen, navigate to the Controller Status by pressing Status > Controller Status.

The controller status screen shows your controller's connection to Hydrowise servers for synchronizing schedule and weather information.

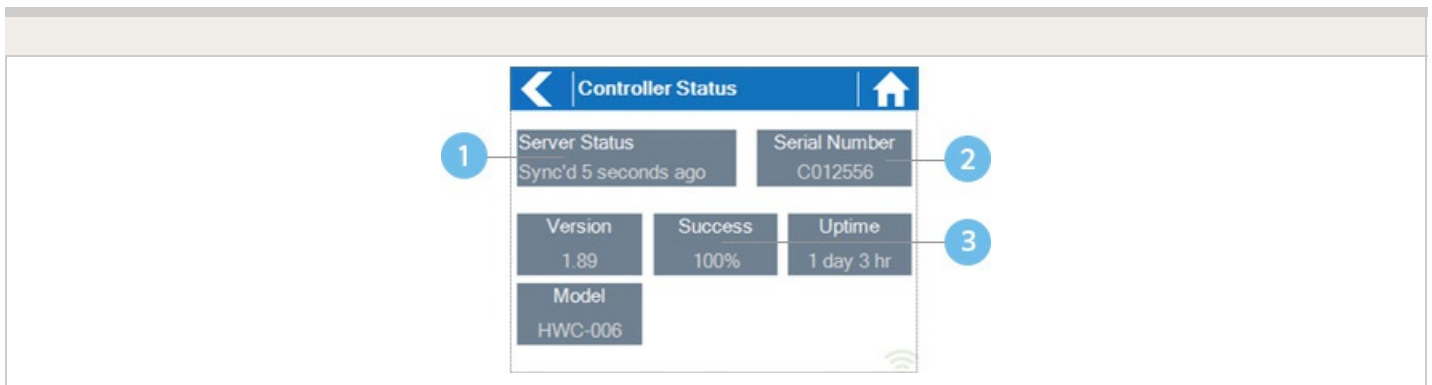

1 Status of Connection to Hydrowise Servers

2 Your Serial Number. Used to link your controller to your account

3 Connection to Hydrowise Success Rate

Server Status

A successful connection to the Hydrowise servers is indicated by **Sync'd** as the Server Status.

SERVER STATUS MESSAGES

| Message | Description |
|------------------------------|---------------------------------------------------------------------------------------------------------------------------------------------------------------------------------------------------------------------------------------------------------------------------------------------------------------------------------------------------------------------------------------------------------------------------------------|
| OK - updated xxx seconds ago | The controller is connected to Hydrowise and last got a configuration update xxx seconds ago. This is the normal state. |
| Wireless Down | Wireless is not connected |
| OK - Updating certificates | The controller is doing an initial upgrade from version 2.x to 3.x software. You should only see this once, if the controller is continually showing this then there is a problem - please contact Anthony with a video of the problem. |
| OK - Downloading Software | The controller is doing a firmware upgrade. During this period no configuration changes will be processed by the controller. |
| Connecting in xxx seconds | The controller is not connected and is waiting xxx seconds before attempting to reconnect to the internet. When a connection fails we do not try to reconnect immediately - there is an escalating delay between 5 seconds the 60 minutes (worst case after 33 unsuccessful connections). There is a "Reconnect Now" button on the Controller Status screen to force a reconnection immediately if you're in front of the controller. |
| Connecting to the Internet | The controller is attempting to connect to the internet |
| | |

| | |
|-------------------------------------|-------------------------------------------------------------------------------------------------------------------------------------------|
| Connecting to Hydrawise | Controller has connected to the internet and is now connecting to the Hydrawise servers |
| OK - subscribing to updates | Controller has connected to Hydrawise and is getting its configuration |
| OK - processing cloud update | Controller is connected to Hydrawise and is processing a configuration change |
| Updating Wi-Fi firmware | The controller is updating the Wi-Fi firmware to 19.5.4. During this period no configuration changes will be processed by the controller. |
| Updating Pro-C adapter | The controller is updating the Pro-C adapter software. During this period no configuration changes will be processed by the controller. |

Success

Success percentage - this is the percentage of time the controller has been connected to Hydrawise. We measure this over a 6-hour time frame. 100% means it was always connected, 80% means that for 20% of the time it was not connected.

A low success percentage will indicate a poor wireless connection between the controller and your access point.

To improve your wireless signal strength you could try the following –

- Move the controller closer to your wireless router.
- Remove any obstacles in a direct line of sight between the controller and your wireless router such as metal items (metal is an extremely good isolator for WiFi signals).
- Move your wireless router closer to the controller.
- Install a higher gain antenna on your wireless router.
- Use Ethernet to a location closer to the controller and install a new wireless router.
- Consider a WiFi repeater/extender between your wireless router and the Hydrawise controller to boost the signal strength.
- Consider moving the controller away from potential sources of interference, including microwave ovens, nearby base stations using adjacent channels or cordless

telephones operating in the 2.4GHz range (you could also change the channel your phone uses).

Note that the Hydrowise unit is designed to work in poor wireless environments. However, if you wish to manually run or stop a zone and the wireless signal is down then these actions will fail.

Offline

If the controller loses internet for more than 24 hours you'll receive a notification email.

The controller will go into an offline mode. In offline mode, your controller won't be able to access local weather conditions such as rainfall or evaporation and will revert to a pre-defined program.

- For Smart Watering zones, the controller will adjust each zone's watering length based on your offline watering budget and will water at each zone's configured peak watering frequency.
- For Time Based Watering zones, the controller will adjust each zone's watering length based on your offline watering budget and will water at each zone's configured watering frequency.
- For more information on Smart and Time Based Watering, see "[Configuring Irrigation Zones](#)" ^[6].
- Note that Cycle & Soak is not supported in Offline Mode and each zone will water for its full watering length without pausing.
- The controller will only water at your configured Program Start Times.

Saving Settings

The controller does not need a battery, all settings are saved in a non-volatile RAM (memory).

Serial Number

The serial number is used to link your actual controller with your Hydrowise account. This number is also printed on the rear of the controller.

Viewing the Serial Number

The serial number is needed when you add your controller to the cloud. This number is found on the controller or using the controller's touch screen.

To link your controller to your account, please refer to this article [How To Remove or Link Your Serial Number](#) ^[1]

NOTE: The serial number **A8000000** is a generic serial number assigned when the controller has not been registered (never connected to the internet to activate). This serial number will show on the touchscreen temporarily until the controller is connected to the internet. To see the real serial number, either to refer to the sticker or put the controller online so it updates to the correct online serial number.

To access the serial number on the touch screen, follow these steps:

1. From the **HOME** screen, click **STATUS**.
2. Click **CONTROLLER STATUS**.

The serial number is shown on this screen. Depending on the model, you may see it at the top or bottom.

NOTE: The serial number contains only letters **a through f** and numbers **0 through 9**.

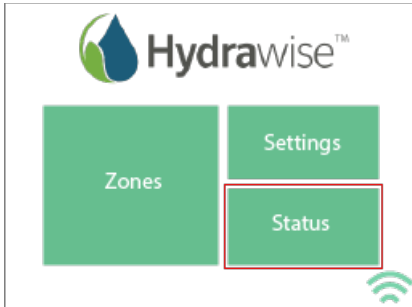
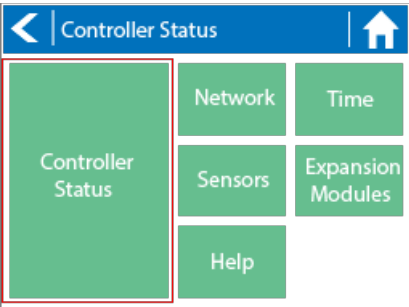
| Serial Number on Screen | |
|----------------------------------------------------------------------------------------------------------------------------------------------------------------------------------------------------------------------------------------------------------------------------------------------------------------------------------------|-------------------------------------------------------------------------------------------------------------------------------------------------------------------------------------------------------------------------------------------------------------------------------------------------------------------------------------------------------------------------------------------------------------------------------------------------------------|
| <p>1.</p>  <p>The screenshot shows the Hydrowise HOME screen with a grid of buttons: 'Zones', 'Settings', and 'Status'. The 'Status' button is highlighted with a red border. A Wi-Fi signal icon is visible in the bottom right corner.</p> | <p>2.</p>  <p>The screenshot shows the 'Controller Status' screen with a blue header bar containing a back arrow, the text 'Controller Status', and a home icon. Below the header is a grid of buttons: 'Controller Status', 'Network', 'Time', 'Sensors', 'Expansion Modules', and 'Help'. The 'Controller Status' button is highlighted with a red border.</p> |
| <p>3.</p> | |

| Controller Status | | |
|----------------------------------|--------------------------|----------------------|
| Server Status Synced 0:05 ago | Serial Number C012345 | |
| Version 2.17 | Success 4 [4] **** | Uptime 1 day 3 hr |
| Model PHC-600 | | |

Serial Number Sticker

X2 WAND Controller - Sticker located on the WAND cartridge device.

HC Controller - Sticker located on the back of the controller

PROHC - Controller - Located inside wiring compartment above the 24 VAC terminals

HPC - Controller - Sticker located on the back of the front panel

HCC - Controller - Sticker located on the back of the front panel

Serial Number 05EF3115



Contains FCC ID: 2ADDHKATWINC1500U

IC ID: 2ADDHKATWINC1500U

PHC 6 Zone Controller

To link your controller to your account, please refer to this article [Linking a Controller to My Account](#) [7].

Viewing the Zone Information

From the Zone Summary screen touch the zone you wish to view.

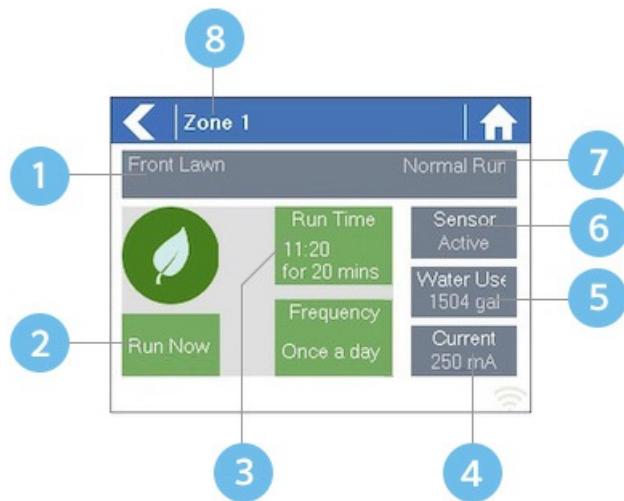

- 1 Zone Name
- 2 Press to Start or Stop To Manually Modify a Zone
- 3 Next Run Time and Length
- 4 Current measured for Zone (12 Zone Pro only)
- 5 Water Usage (if HC Flow meter is used)
- 6 Sensor State (if configured)
- 7 Type of Watering Schedule
- 8 Current Zone Number

The Zone Status screen allows you to view the following information –

- **Zone Name:** This is the name of the Zone you've configured in the Hydrowise app
- **Sensor:** The current sensor state if configured in the Hydrowise app.
- **Water Usage:** Water usage for this zone run. This is only shown if you have a flow meter installed and the zone is currently running.
- **Current:** Indicates the current that all solenoids are using (including a master solenoid if configured). Generally speaking, this value ranges from 200mA to 600mA depending on the number of solenoids attached to a single zone output. The controller has a built in fail-safe to automatically stop your zone if more than approximately 800mA is

detected as this may indicate a faulty solenoid or wiring.

The Zone Status screen also allows you to manually start a zone using the Run Now button. When started, the zone will run for the zone's default configured run length. This can be overridden by clicking on Run Time prior to manually starting the zone.

When a zone is running the Run Now button will change to Stop, allowing you to stop a running zone.

Viewing Network Information / Testing Internet Connectivity / Connection Status

In this article, you will find information on viewing the network information, how to test the network, and how to check your connection status.

Viewing Network Information

From the Home screen, navigate to the Network Status by pressing Status > Network.

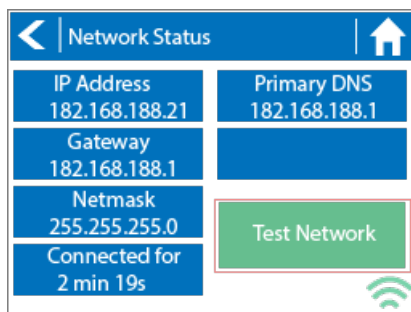

- IP Address (set by your wireless router)
- DNS Address (set by your wireless router)

- Network Test Button

All settings on this page are provided to the controller by your wireless router when it first connects via a protocol, known as DHCP. If any of these settings appear incorrect please change them in your wireless router.

Test Network

Once the controller has successfully connected to your wireless router the Test Network button can be used to test network connectivity for troubleshooting purposes. The network test will verify connectivity to 4 destinations.

Checking WiFi Performs a ping test to the Gateway address listed in the Network Status screen. If this test fails, check that you don't have MAC address filtering enabled on your router.

Checking DNS Performs a ping test to the DNS address listed in the Network Status screen. If this test fails, check that the DNS address is correct – if it is wrong then correct the DNS address under DHCP Settings on your wireless router. It is possible that this test may fail if the DNS server doesn't accept ping requests which do not indicate an issue.

Checking Internet Performs a ping test to the Google server at IP address 8.8.8.8. This is a well-known server which accepts ping requests on the internet. If this test fails then it indicates an issue with the internet configuration of your wireless router.

Checking Hydrawise Performs a ping test to the Hydrawise servers. If this test fails then it may indicate an issue with the internet configuration of your wireless router.

Checking Connection Status

The controller will show different status messages while connecting to your wireless router.

1. Click on **SETTINGS**.
2. Next, click on **WIRELESS**.

| STATUS | DESCRIPTION |
|--------|--------------------------------------------|
| | Controller is currently scanning for local |

| | |
|------------------------------|------------------------------------------------------------------------------------------------------------------------------------------------------------------------------|
| Looking for Wireless | wireless networks. |
| Connecting to | Controller is currently trying to connect to your wireless router. |
| Waiting for IP | Controller has connected to your wireless router and is waiting for your wireless router to give it an IP address. Your wireless router must be configured as a DHCP server. |
| Connected | Controller has successfully connected to your wireless router. |
| Local Connection Only | Controller is acting as a local wireless router. |

Troubleshooting Wireless Connection Issues

After entering your wireless settings, the controller will connect to your access point. The connection process takes about 30 seconds.

Upon successful connection the wireless status will show **Connected**.

If your controller fails to connect to your wireless router check the following:

- Your password is entered It is case sensitive and must be at least 8 characters long.
- Check that the wireless security types match between the controller and your wireless Hydrowise recommends use of WPA2 security between the controller and your wireless router.
- We have WiFi specifications here: [WiFi Specs](#) ^[8]

Manual Operation from the Controller

You can run an irrigation zone on demand from the Hydrowise unit prior to having the system connected to your home Wi-Fi network.

IMPORTANT: If the controller is connected to WiFi, the app events will not show the user who performed the manual command.

The command from controller shown in events:

● Wed 19th August @ 7:15am
Zone Front Grass has run for 37 seconds

The command from app shown in events:

● Wed 19th August @ 7:15am - by Brendan - Hunter Technical Support
Scheduling Front Grass to run for 20 minutes at 07:15AM (Los Angeles Time).

Running a SINGLE zone manually from the controller

From the **Home** screen, navigate to the **Zone Summary** screen by pressing **Zones**.

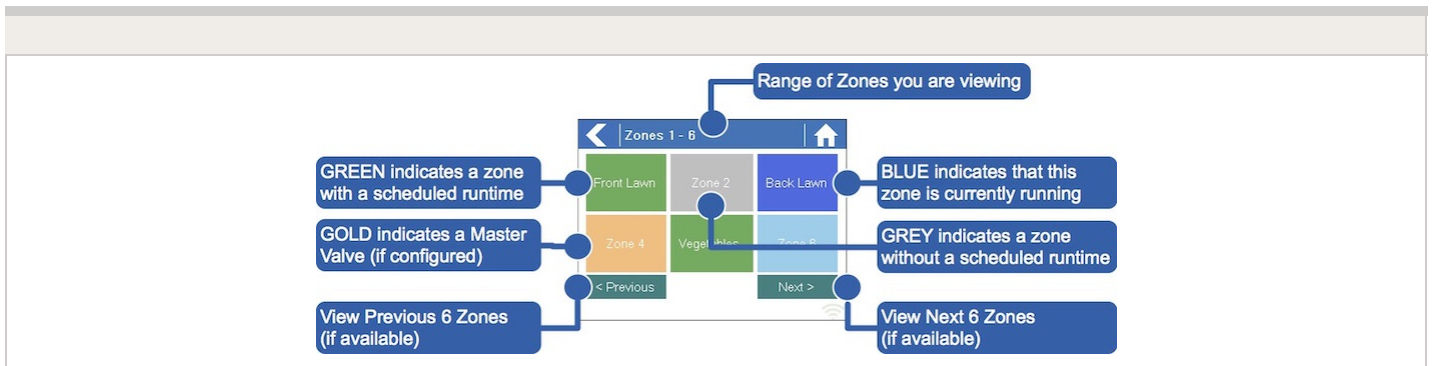

The Zone Summary screen shows the status of six zones at a time. To view the next or previous group of zones, use the **Next** and **Previous** buttons. The current range of zones that you are viewing is indicated at the top of the screen.

From the Zone Summary screen, touch the zone you wish to view.



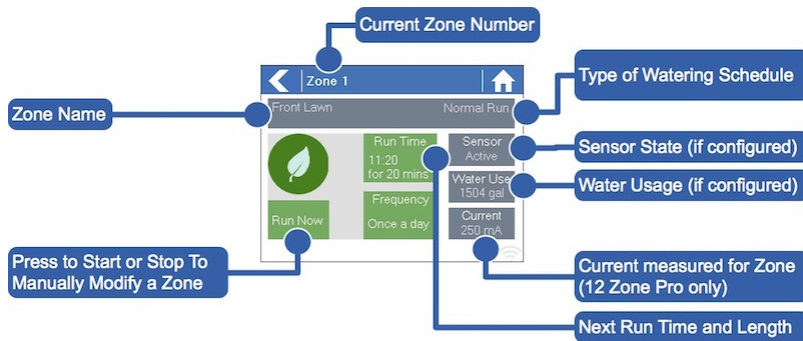

From the Zone Status screen, you can manually start a zone using the **RUN NOW** button. When started, the zone will run for the zone’s default configured run length. This can be overridden by clicking on **Run Time** prior to manually starting the zone.

When a zone is running, the **Run Now** button will change to **Stop**. This allows you to stop a running zone.

Running ALL ZONES manually from the controller

From the **Home** screen, navigate to the **Zone Summary** screen by pressing **Zones**.

You have the ability to stack zone runs when there’s already a zone running. As you turn on zones individually at the controller, they will be put in a queue waiting to run when the last one is finished.

From the Zone Status screen, you can manually start a zone using the **RUN NOW** button. When started, the zone will run for the zone’s default configured run length. This can be overridden by clicking on **RUN TIME** prior to manually starting the zone.

In addition to setting a single zone to run, you can stack additional zones to run in a sequential order. After you started your first zone, repeat the steps for any other zone you would like to run. The zones that will run **NEXT**, will be changed to a **LIGHT BLUE** color in the controller screen.

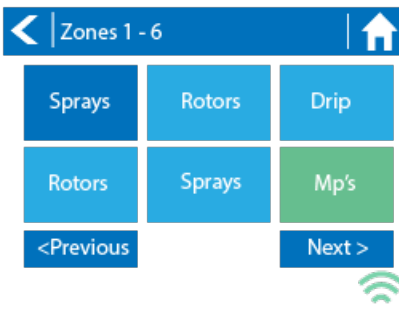

GREEN indicates a zone with a scheduled start time.

BLUE indicates that a zone is running

LIGHT BLUE indicates a zone that is queued up to run.

GREY indicates a zone without a scheduled start time (not shown).

Controller has a Blank Display

First, make sure there is power to the controller's outlet. Use a test lamp or any other 110VAC device to determine if there is voltage at the outlet. If there isn't power, or if you have a controller that is hard wired, check the circuit breaker at the main breaker box.

Caution: High voltage testing on the transformers primary power side should only be done by a professional electrician or irrigation contractor.

Checking Transformer Voltage

If you have power at the outlet, the next thing to check is the transformer output. Use a voltmeter to check the voltage either on the two transformer wires or at the two AC screw terminals on the controller. The transformer should have an output in the range of 24VAC to 28VAC.

If the wall outlet has 110VAC and the transformer has no voltage output, you need to replace the transformer.

Cycle Controller Power

If you have voltage at both the wall outlet and the transformer output and you still have a blank display, try cycling the power on the controller. To cycle the power on the controller:

1. Remove power by unplugging the transformer from the wall outlet or by turning off the circuit at the breaker box.
2. Wait a few minutes.
3. Plug the controller transformer back into the electrical receptacle, or turn the breaker panel switch back on.

Note: If this doesn't restore the display, the controller will need to be replaced.

Flow Meter Pressure Loss Chart

HC FLOW METER PRESSURE LOSS CHART

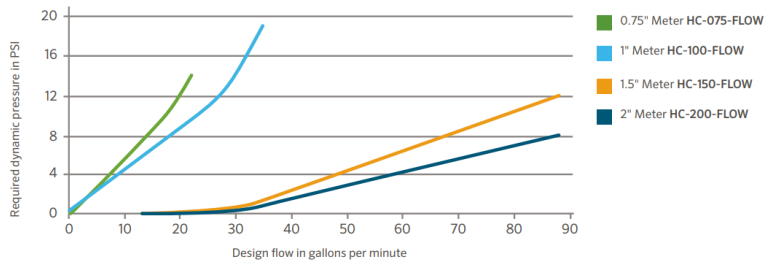

Flow Meter - Configuration

Assigning the Meter

Please view the steps and screenshots to access this feature:

1. Click on "**Sensors**" from the home dashboard.
2. Add "**Sensor.**"
3. Choose a **name**, **sensor type**, and **controller input** (flow related only).
4. Choose which **zones** should be linked to the sensor.
5. Click **ok** when finished.

Step 1

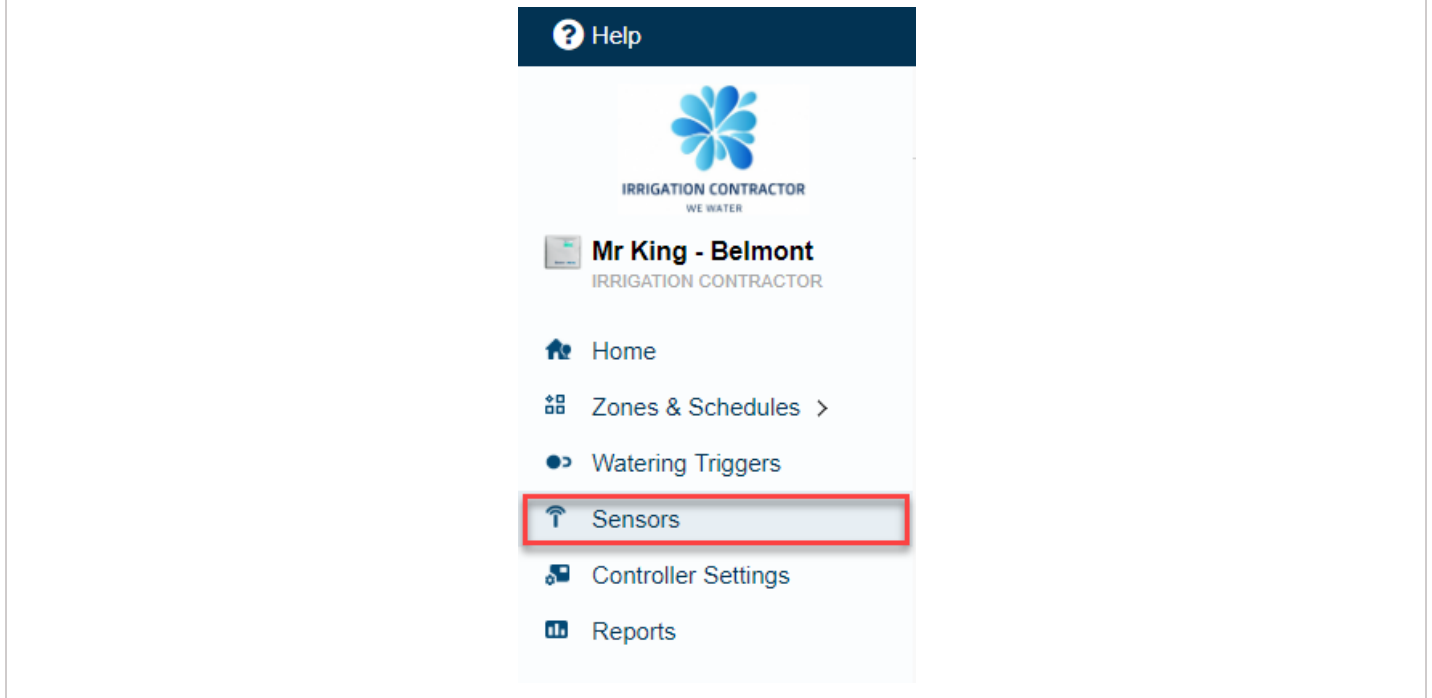

Step 2

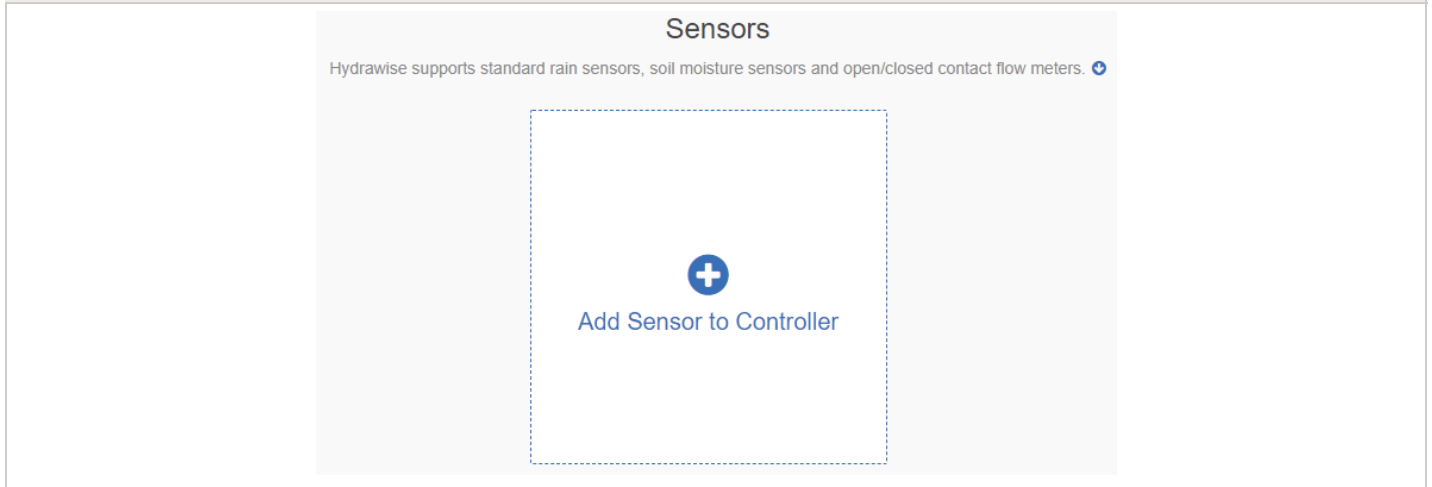

Step 3

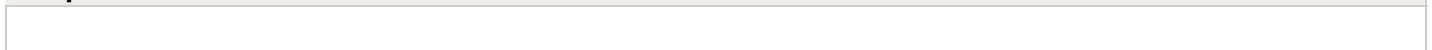

Add Sensor ✕

Sensor details ▶ **Set zones**

Sensor Name
Assign a descriptive name for this sensor

Flow Meter

Type of Sensor
Choose the type of sensor you have installed. You can also create a custom sensor type if you have something non standard.

¼ inch NPT Flow Meter

Create New Sensor Type...

Controller Input
Choose the input on the controller that this sensor is wired to

SEN-1

Cancel < Prev Next > ✓ OK

Step 4

Add Sensor ✕

Sensor details ▶ **Set zones**

Select Zones
Select the zones which will use this sensor

Available zones

- Carioca Court
- Back Grass
- Back Drip
- Diamond Street Controller**
- Front Grass
- Front Flowers
- Back Drip

Selected zones

- Carioca Court
- Front Grass
- Street Drip
- Front Drip

Cancel < Prev Next > ✓ OK

Flow Meter - Installation Quick Start Guide

In this Quick Start Guide, you will learn how to install and configure your flow meter. For support of Hydrowise™ cloud software or help with your Hydrowise account, visit the support section [here](#) [9]. For specification information, refer to the section [here](#) [10].

The flow meter consists of two parts:

- 1. Flowmeter body:** The flowmeter body contains an analog dial for manual readings as follows. Your flow meter will have 3 wires protruding from the body. The wires need to be connected to the sensor inputs on the controller for readings in the software application. In all models, only 2 wires (blue and white) are used.
- 2. Adapter:** Each flow meter has an adapter to allow connection to your irrigation system.

| DIAL MARKING | MEASUREMENT UNIT |
|--------------|------------------|
| X0.01 | 0.1 gallon |
| X1 | 1 gallon |
| X10 | 10 gallons |
| X100 | 100 gallons |

3. Flowmeter location: Flow meters are installed between the master valve and zone valves. To avoid false alerts, there should be no water taps or other uncontrolled water use on the downstream side of the flow meter. If all solenoids connected to the controller are not grouped together, it may be necessary to install more than one flow meter. For proper installation and optimal water flow, use the chart below when determining pipe length. The pipe bringing water into the flow meter needs to be 10 times longer than the width of the pipe. The pipe carrying water away from the meter needs to be 5 times the width of the pipe.

| PIPE | 10X-BEFORE | 5X-AFTER |
|------|------------|----------|
| ¾" | 7½" | 3¾" |
| 1" | 10" | 5" |
| 1½" | 15" | 7½" |
| 2" | 20" | 10" |

4. Cable (shielded direct-burial cable must be used): Two-wire cable is required. The cable gauge is determined by the total length of cable between the controller and the flow meter. The cable should consist of 2 dedicated wires and must not be in the same conduit or cable bunch as the solenoid wires. Do not share the common wire of the solenoids with the common of the sensors.

Flow Meter Cable Length Chart

| WIRE SIZE | MAX LENGTH |
|-----------|------------|
| Gauge | Feet |
| 20 | 240 |
| 18 | 1,000 |

IMPORTANT: Shielded direct-burial cable is commonly available. Manufacturers include Paige Electric and Regency Wire.

The following instructions assume you have already installed your Hydrawise controller

1. Flowmeter body: The flow meter has a marking on the body indicating the direction of water flow. Installation of the flow meter must be in the correct orientation with water flowing in the direction of the arrow on the flow meter body. All HC Flow Meters must be installed horizontally with the dial facing upward.

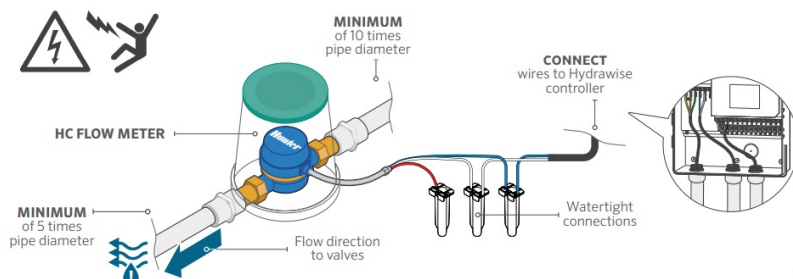

7

2. Connect flowmeter wire: Two-wire cable is required. The cable required to connect

your flow meter must be dedicated to the flow meter and not shared with the common wire of the valves or other sensors. The cable gauge is determined by the total length of cable between the controller and the flow meter. The general rule is that 0.5 mm (20GA) wire is good for a run of up to 240'. Connect the wires to your Hydrawise controller.

| WIRE COLOR | SENSOR TERMINAL BLOCK |
|------------|----------------------------------------------------------------|
| White | Common |
| Blue | Sen 1 or Sen 2 |
| Red | Not used: Wires should be capped with waterproof splice |

* Shield and bare wire should be connected to the controller ground terminal if available.

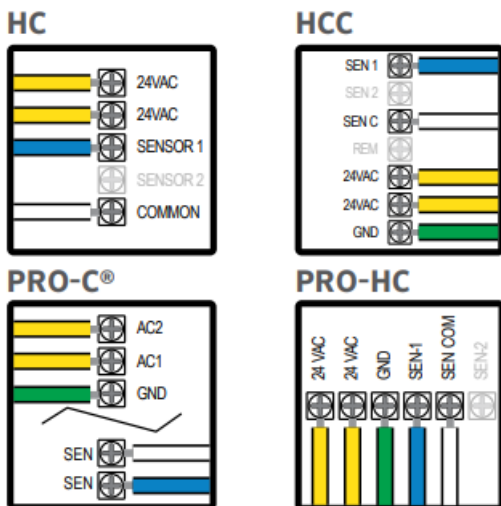

IMPORTANT: All wire connections should be done using waterproof connectors, such as 3M 316IR or 3M DBY.

Use your Hydrawise account to complete your flow meter configuration.

1. **Log in to your account:** Enter your login information.
2. **Create a flow sensor:** It is important that you select the correct flow meter when configuring your Hydrawise app. Choosing the wrong model may cause the Hydrawise controller to create false alerts in the software.

| HC FLOW METER SELECTION CHART | | |
|-------------------------------|----------------|------------------------|
| METER SIZE | DESCRIPTION | U.S. GALLON PULSE RATE |
| ¾" | ¾" flow meter | 1 pulse per 0.1 gallon |
| 1" | 1" flow meter | 1 pulse per 1 gallon |
| 1½" | 1½" flow meter | 1 pulse per 1 gallon |
| 2" | 2" flow meter | 1 pulse per 1 gallon |

3. Assign zones to the flow sensor: Refer to hunter.direct/hchelp for app/software setup information

Flow Meter - Installation Tips

Flow meters are supplied with [detailed installation instructions](#) ^[11].

The flow meter wires need to be cabled back to the controller and connected to the **Sensor** inputs on the controller. See chart below for wiring standard Hydrawise flow meters (Sizes include ¾", 1", 1.5", 2")

| FLOW METER WIRE | SCREW TERMINAL | CONTROLLER |
|-----------------|-------------------|------------|
| BLUE | SEN 1, 2 | HC |
| BLUE | SEN 1, 2 | PRO-HC |
| BLUE | SEN | HPC-FP |
| WHITE | COM | HC |
| WHITE | SEN COM | PRO-HC |
| WHITE | SEN | HPC-FP |
| RED | Not Used, Cap off | N/A |

The tips below include all the necessary key points of the install to avoid any false alerts or readings.

| Installation Steps | Description |
|--------------------|-------------|
| | |

| Flow Meter Body | Flow meters are designed to be installed horizontally only , with the dial facing up. Not vertically. Analog dial for manual readings in U.S. are shown in US gallons (Int. customers the dial reads in Cubic Meters). Units can be changed in App to gallons or liters. | | | | | | | | | | | | | | | |
|-------------------------------------------|------------------------------------------------------------------------------------------------------------------------------------------------------------------------------------------------------------------------------------------------------------------------------------------------------------------------------------------------------------------------------------------------------------------------------------------------------------------------------------------------------------------------------------|----------|------------|----------|------|------|-------|----|-----|----|------|-----|------|----|-----|-----|
| Adapter | Brass unions included to fit your irrigation system. | | | | | | | | | | | | | | | |
| Entry Location | <p>Install between the master valve and zone valves. Meter should be installed 10 times pipe diameter before and 5 times after with straight pipe and no fittings. See example:</p> <table border="1"> <thead> <tr> <th>Pipe</th> <th>10x-Before</th> <th>5x-After</th> </tr> </thead> <tbody> <tr> <td>3/4"</td> <td>7.5"</td> <td>3.75"</td> </tr> <tr> <td>1"</td> <td>10"</td> <td>5"</td> </tr> <tr> <td>1.5"</td> <td>15"</td> <td>7.5"</td> </tr> <tr> <td>2"</td> <td>20"</td> <td>10"</td> </tr> </tbody> </table> | Pipe | 10x-Before | 5x-After | 3/4" | 7.5" | 3.75" | 1" | 10" | 5" | 1.5" | 15" | 7.5" | 2" | 20" | 10" |
| Pipe | 10x-Before | 5x-After | | | | | | | | | | | | | | |
| 3/4" | 7.5" | 3.75" | | | | | | | | | | | | | | |
| 1" | 10" | 5" | | | | | | | | | | | | | | |
| 1.5" | 15" | 7.5" | | | | | | | | | | | | | | |
| 2" | 20" | 10" | | | | | | | | | | | | | | |
| Cable used (shielded cable only) | <p>18 gauge - 1000 foot max Length. Shielded direct burial cable must be used. Cable should consist of two dedicated wires and must not be in the same conduit, cable bundle or trench as the solenoid wires. DO NOT share common wire. Shielded cable is commonly available, here are some manufacturers (Paige ^[12] & Regency ^[13]) For additional information on avoiding electrical interference, see below:</p> | | | | | | | | | | | | | | | |
| Flow meter body | Arrow indicates direction of flow. | | | | | | | | | | | | | | | |
| Wire Connection | Blue/White wire only, red not used . See sensor configuration ^[14] for more info based on model controller. | | | | | | | | | | | | | | | |
| Log in to your account | Enter your login ^[15] information. | | | | | | | | | | | | | | | |
| Create your flow sensor | App will show options for all HC meters. | | | | | | | | | | | | | | | |
| Creating Alerts | See link here ^[16] | | | | | | | | | | | | | | | |
| Reading Meter | See link here ^[17] | | | | | | | | | | | | | | | |
| Testing Meter | See link here ^[18] | | | | | | | | | | | | | | | |

Avoid Electrical Interference

- Always use shielded cable, between the controller and the HC Flow Meter.
- At the controller end, using the shield (foil wrap) and the bare wire connect them to the controller GND terminal (not required for HC controllers).
- Do not connect the other end of the Shield or the bare wire to the Earth or a grounding stake
- Use Waterproof wire connectors at the flow meter, such as the [3M-DBOB](#) ^[19].
- Shielded cable is commonly available, here are some manufacturers. [Paige](#) ^[12] & [Regency](#) ^[13]

In the event you continue to receive bad readings or false alerts, please contact us support@hydrawise.com ^[20]

Flow Meter - Specifications

HC FLOW METER SPECIFICATIONS



| | HC-075-FLOW (¾") | HC-100-FLOW (1") | HC-150-FLOW (1½") | HC-200-FLOW (2") |
|---------------------------------------|-----------------------------|-----------------------------|------------------------------|--------------------------|
| Inlet/outlet connection size | ¾" NPT body, male thread | 1" NPT body, male thread | 1½" NPT body, male thread | 2" NPT body, male thread |
| Meter internal diameter | ¾" | 1" | 1.5" | 2" |
| Minimum flow (GPM) | 0.22 | 0.3 | 0.88 | 1.98 |
| Maximum recommended flow (GPM) | 15 | 30 | 66 | 105 |
| Maximum flow rate (GPM) | 21 | 34 | 88 | 132 |
| Dial reading (US gal) | 1 pulse per 0.1 U.S. gal | 1 pulse per 1 U.S. gal | 1 pulse per 1 U.S. gal | 1 pulse per 1 U.S. gal |
| Maximum working pressure (PSI) | 230 | 230 | 230 | 230 |

Flow Meter - Reading Meter

The Hydrowise flow meters come in a US Gallon reading for domestic and metric reading called M³ (Meters Cubed 1000 Liters) for international. Conversion rate for metric meters is 3.78 Liters to 1 US Gallon if required.

See example of meter reading below in US gallons:

| | | |
|--------|-------|-----------------------|
| Fig. 1 | X100 | 8100 Gallons |
| Fig. 2 | X10 | 814X.XX Gallons |
| Fig. 3 | X1 | 8142.XX Gallons |
| Fig. 4 | X0.1 | 8142.4X Gallons |
| Fig. 5 | X0.01 | 8142.46 Gallons Total |
| | | |

| | | |
|--------|----------------|------------------------------------|
| Fig. 6 | Size meter | 1" |
| Fig. 7 | Flow Indicator | Wheel spins when water is flowing. |

We have a flow that has gone through the meter of 8,142.46 gallons.

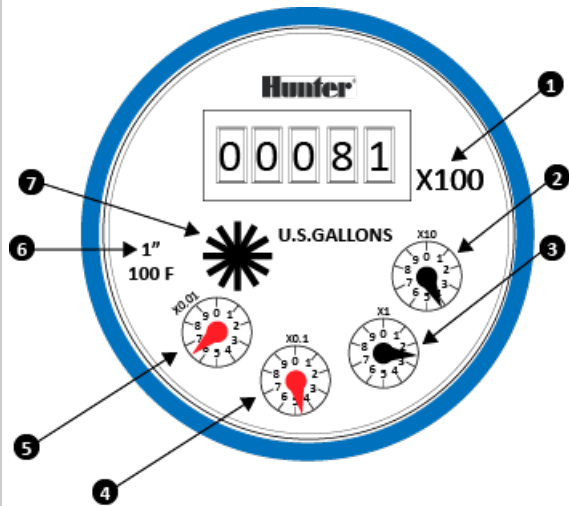

See example of meter reading below in Litres:

| | |
|--------|------------------------------------|
| Fig. 1 | 8,000 Litres |
| Fig. 2 | 8,200 Litres |
| Fig. 3 | 8,220 Litres |
| Fig. 4 | 8,224 Litres |
| Fig. 5 | 8,224.7 Litres Total |
| Fig. 6 | Wheel spins when water is flowing. |

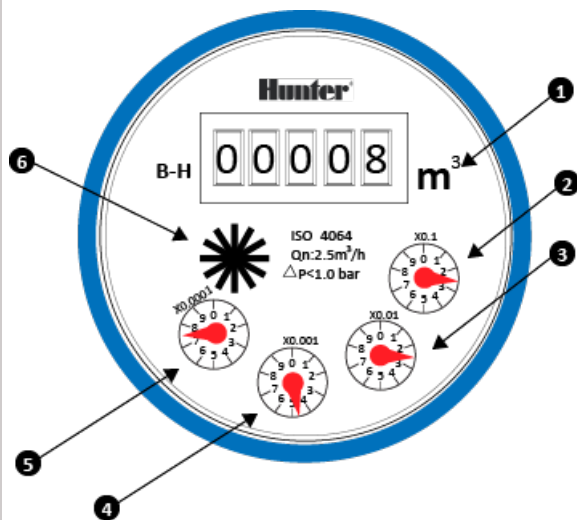

So we have a flow that has gone through the meter of 8,224.7 Litres. To calculate this into Gallons is easy $8,224.7 / 3.78 = 2175.84$ gallons.

Flow Meter - Testing Meter

If your flow meter is working but is not recording data in your **Dashboard** or events, follow the steps here:

1. Make sure sensor is configured ^[21] in the software.
2. Make sure controller is online. If not, please use link ^[22] for Wi-Fi troubleshooting steps.
3. Remove the wire splices at the flow meter connection in the field. Tap the two wires together that run to the controller 10 times, as each contact will record a pulse. Refresh the app to see if the flow usage was registered.
4. If app registered flow usage, your wiring and system are set up correctly. Reconnect to the flow meter and run a large flow (lots of sprinklers) zone. Did you get a flow on your app? If **YES**, all is OK. If **NO**, contact support@hydrowise.com ^[23].
5. If app did not register flow usage, test the sensor inputs on the controller. You can use the same method with a paper clip or wire to make contact between sensor 1 or 2 and the common terminal. Do this 10 times and then check for flow data usage at the home screen. If **YES**, there is a problem with the wire running to the flow meter. If **NO**, contact support@hydrowise.com ^[23].

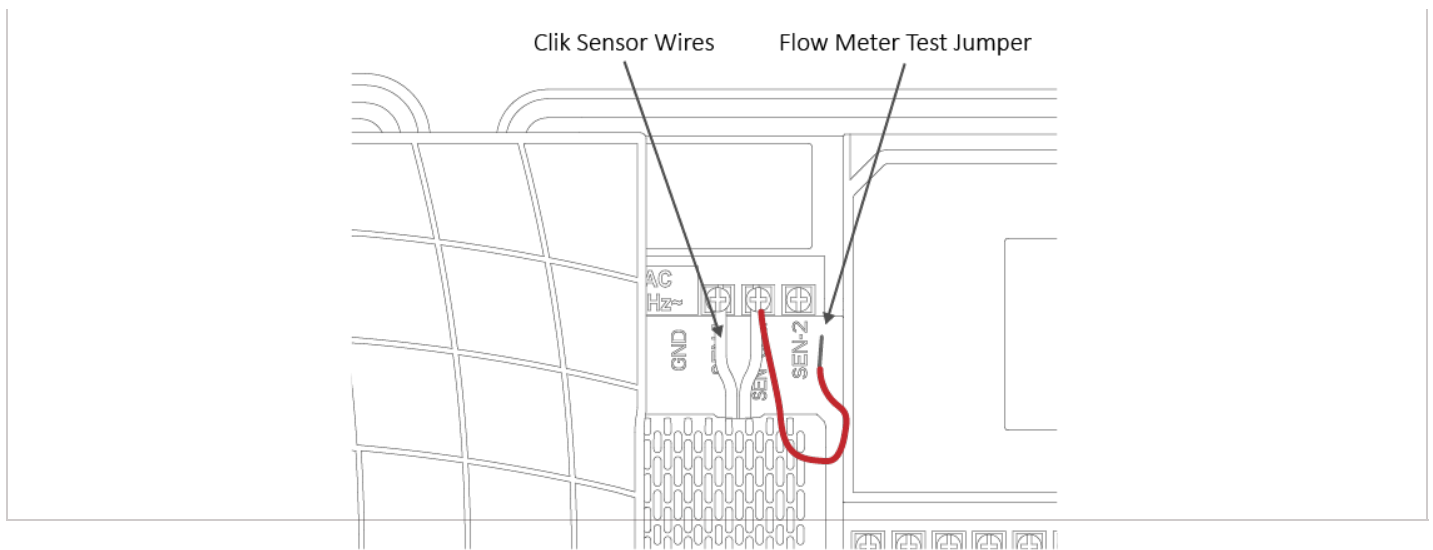

IMPORTANT: Our controller is not polarity sensitive. There is no risk of electric shock when performing these tests. However, if you feel uncomfortable, please contact a qualified technician or irrigation specialist for further assistance.

NOTE: If it works at the controller end but not the flow-meter end, there is a wiring fault.

If it doesn't work at the controller end, contact support@hydrawise.com [23].

If it works at both ends, but still does not register flow on the app, contact support@hydrawise.com [23].

Flow Meter - Custom Flow Sensor Configuration

To add a custom flow sensor, go to [Sensors](#) [24] from your web browser or smartphone application.

1. Click **Add Custom Sensor Type**

STEP 1

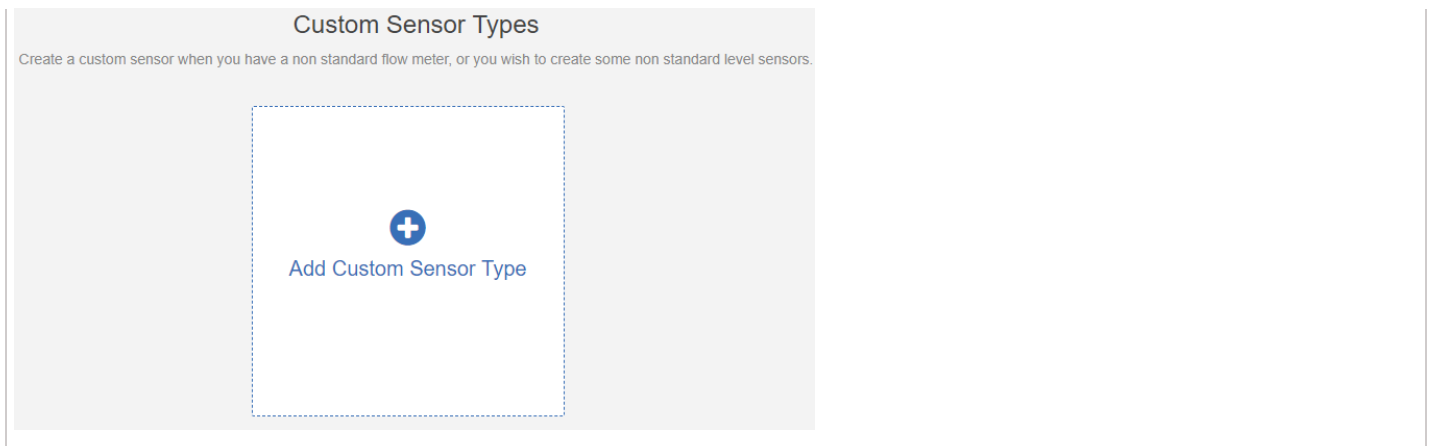

A dialogue box will appear for you to enter your custom flow meter details. Make sure you enter the calibration details for your custom pulse-based flow meter. Please refer to the manufacturer specifications to find out the calibration. Otherwise, you will not get accurate readings to display on your flow data.

NOTE: For our system to detect the correct flow data and reflect it on your **Dashboard** reports, any third-party flow meter used must be a true pulse flow meter or have a reed switch. We aim for a minimum of 10 pulses per min and a maximum of 120 pulses per min. That means if the flow rate was 10 gal per min, 1 pulse per gallon needs to be set.

When using a third-party flow meter, please ensure it meets the specs above and is calibrated correctly. Otherwise, data will not reflect accurately in reports. Also, note that the

wiring is not polarity sensitive. As long as you have one wire in a **Sensor Port** and a **Sensor Common**, the device will work correctly. For flow meters that use three wires and meet the specs above, configure the wiring until you find the two correct wires to use.

Can I Use One Flow Meter for Two Controllers?

For this installation, we suggest a few tips to make sure you do not receive any unnecessary alerts.

When using multiple controllers on the same flow meter, there are two alerts we do not recommend using.

1. **HIGH FLOW LEAK** - High water usage with no zones running.
2. **SLOW LEAK** - Water usage over last hour with no zones running.

These alerts are controller specific so when the controller with the flow meter is not in operation, it does know about the other controller operation.

Tips:

1. The inter station delay ^[25] should be set for 10-30 seconds. We do not recommend any higher.
2. Change the gallons in the alert to be **HIGHER** (e.g. alert from 5 gallons to 20 gallons).
3. Wire to only **ONE** of the two controllers.
4. Configure the sensor to the controller that has the wire connection.
5. Move **AVAILABLE** zones from both controllers into **SELECTED ZONES**.

For more information on configuring and wiring, visit support section here ^[26].

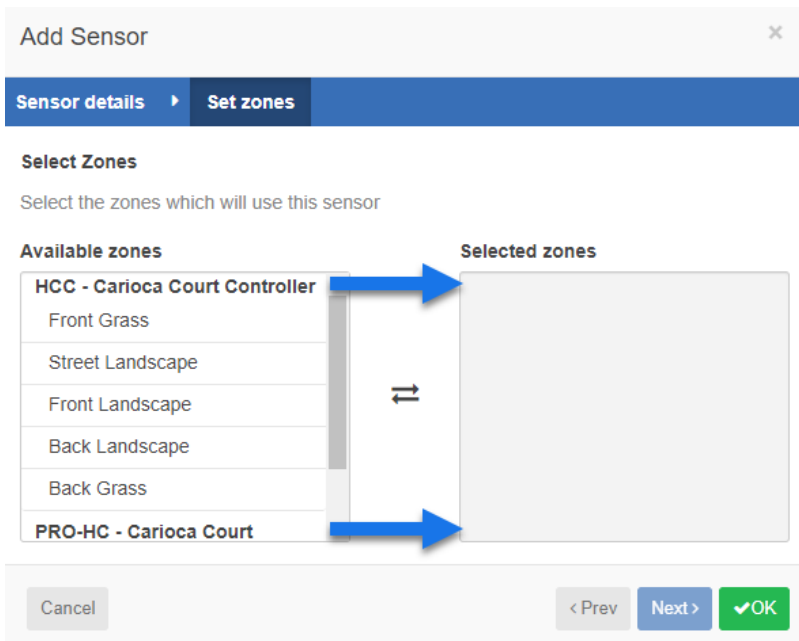

Following these parameters should allow the system to run normal when using one flow meter with multiple controllers.

Flow Meter - Winterization

We recommend that a qualified licensed contractor perform this type of winterization method. The blowout method utilizes an air compressor with a cubic foot per minute (CFM) rating of 80-100 for any mainline of 2" or less. The compressor is attached to the mainline via a quick coupler, hose bib, or other type connection, which is located beyond the backflow device. Compressed air should not be blown through any backflow or flow meter device. For additional winterization procedures, we highly recommend contacting the local

dealer for the most common local practices. In the event you need to blow upstream from where the flow meter is located, we recommend bypassing the meter by temporarily using one of two options.

1. Installing a SCH 80 or galvanized nipple. See the size chart below:

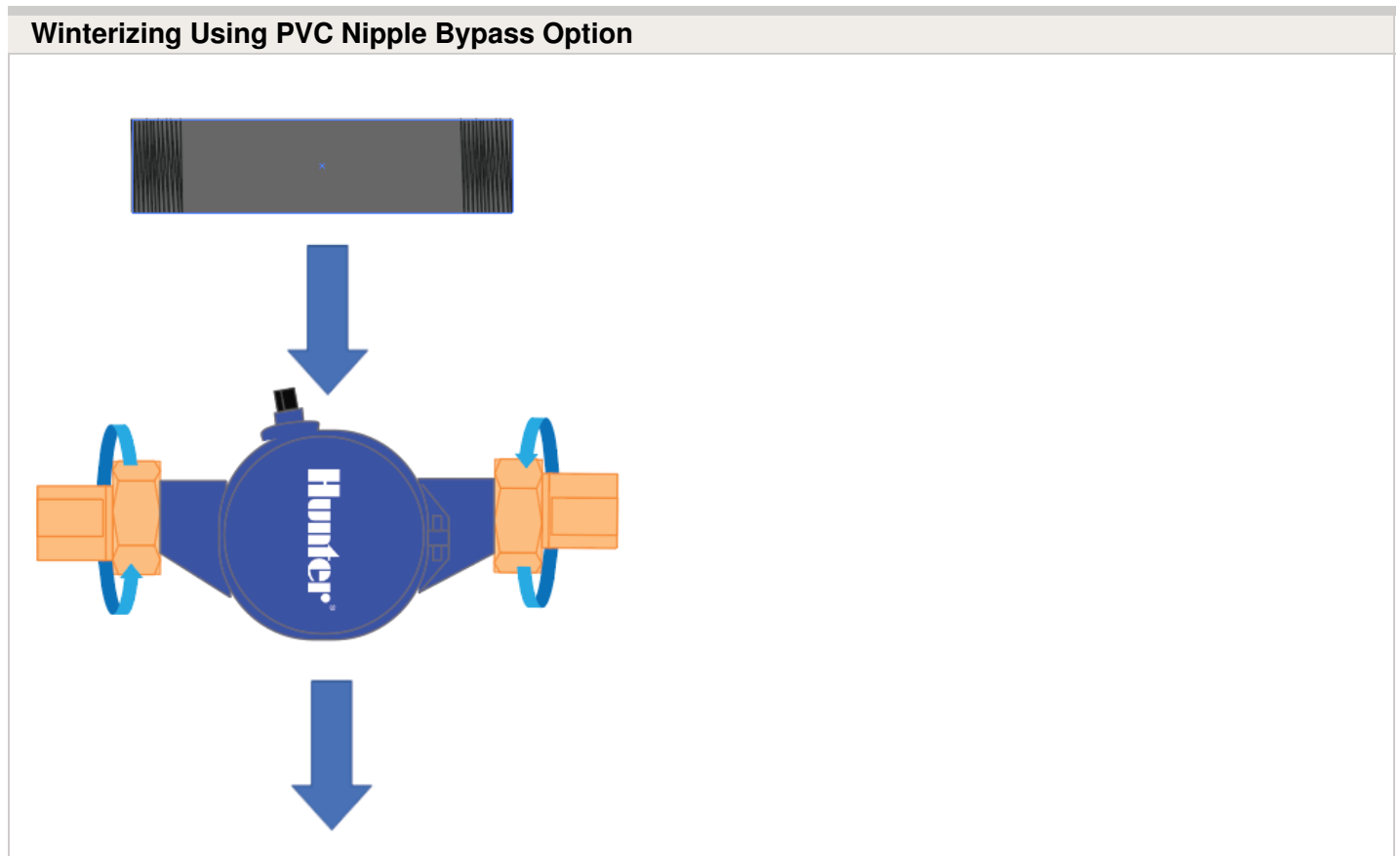

| Model | Description | Male-Thread NPT | Nipple Length |
|-------------|-----------------------------------------------------|-----------------|---------------|
| HC-075-FLOW | ¾" NPT body, male thread with 1" NPT male adapter | 1" NPT | 5" |
| HC-100-FLOW | 1" NPT body, male thread with 1.5" NPT male adapter | 1 ¼"NPT | 5" |
| HC-150-FLOW | 1½" NPT body, male thread with 2" NPT male adapter | 2"NPT | 11 ¾" |
| HC-200-FLOW | 2" NPT body, male thread with 3" NPT male adapter | 2 ½"BSP | 11 ¾" |

2. A second option would be to install PVC tee diverters but this is done more efficiently

during NEW installation. The meter will have to be removed manually after the blowout to make sure any residual water is not sitting inside through the winter months.

Winterizing Using PVC Diverter Option

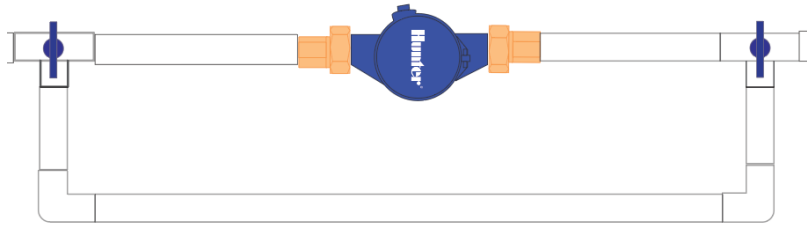

Find a Hunter Distributor closest to you using our interactive lookup - [Get Hunter](#) ^[27]

Wire Distance (Controller to Valve)

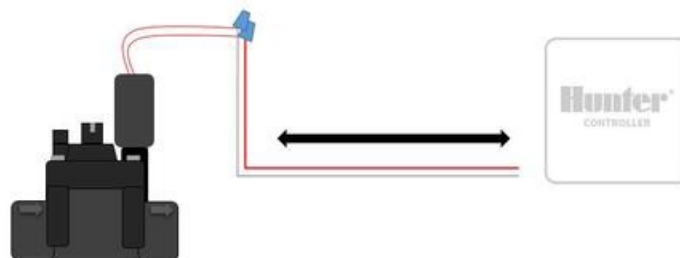

Below is a chart indicating the maximum wire runs that can be used when installing

Hunter AC solenoids and valves.

Valve Wire Sizing (Maximum One-Way Distance in Feet Between Controller and Valve)

| Ground Wire Size | Control Wire (ft) | | | | | | |
|------------------|-------------------|-----------------|-----------------|-----------------|-----------------|--------------|--------------|
| | 18 AWG / 1.0 mm | 16 AWG / 1.2 mm | 14 AWG / 1.6 mm | 12 AWG / 2.0 mm | 10 AWG / 2.5 mm | 8 AWG / 3 mm | 6 AWG / 4 mm |
| 18 AWG / 1.0 mm | 850 | 1040 | 1210 | 1350 | 1460 | 1540 | 1590 |
| 16 AWG / 1.2 mm | 1040 | 1340 | 1650 | 1920 | 2150 | 2330 | 2440 |
| 14 AWG / 1.6 mm | 1210 | 1650 | 2150 | 2630 | 3080 | 3450 | 3700 |
| 12 AWG / 2.0 mm | 1350 | 1920 | 2630 | 3390 | 4170 | 4880 | 5400 |
| 10 AWG / 2.5 mm | 1460 | 2150 | 3080 | 4170 | 5400 | 6670 | 7690 |
| 8 AWG / 3 mm | 1540 | 2330 | 3450 | 4880 | 6670 | 8700 | 10530 |
| 6 AWG / 4 mm | 1590 | 2440 | 3700 | 5400 | 7690 | 10530 | 13330 |

Pump Start Relay Wiring and Online Setup

In this article, we will discuss the following topics:

- Summary
- Operation Chart
- Wiring (24 VAC)
- Wiring to Power Source
- Online Setup
- Pump Start Relay Operation per Zone

Summary

When a system requires the use of a booster pump or pulls water directly from a creek or pond, it's imperative to include a relay to activate the pump each and every time. A pump start relay is a relay box that activates a pump every time a zone is activated from the controller. Zone valves are the individual valves that operate a group of sprinklers or drip emitters. Hydrowise controllers support 6- to 54-zone valves, depending on the model. Typically, one zone valve is turned on at a time and controls the irrigation in a specific area of your landscape. Whenever one of the irrigation zone valves is told to open by the controller, the controller also signals the pump start relay to turn the pump on.

Operation Chart

| Controller Model | Set Pump Operation |
|------------------|--------------------------------|
| HC | ON or OFF by All Zones |
| PRO-HC | ON or OFF by All Zones |
| HPC | ON or OFF by Zone or All Zones |
| HCC | ON or OFF by Zone or All Zones |

Wiring (24 VAC)

Use a minimum distance of 15' (4.5 m) between the controller and the relay to dampen electromagnetic noise. In addition to this recommendation, Hunter also recommends all controllers be mounted 15' (4.5 m) away from pumps and high-voltage devices.

1. Detach the pump start relay cover plate by removing the four screws with Phillips screwdriver.
2. Run a single wire from the "common" terminal on the controller to one of the yellow wires on the pump start relay.
3. Run a single wire from the "P/MV" terminal on the controller to the other yellow wire on the pump start relay.
4. Use wire nuts to make the connections and verify they are secure.
5. Install pump start relay cover plate and four screws. Close and lock the cabinet door.
6. Route wire through the conduit or one of the openings on the bottom of the cabinet.
7. Strip 1/2" (13 mm) of insulation from the ends of all wires. Secure the valve common wire to "**COM**" (Common) terminal. Attach the opposite control wire to the M/V terminal.

| Pump Start Relay Maximum Wire Lengths | | | | | | |
|---------------------------------------------------|--------|--------|--------|--------|----------|----------|
| MAXIMUM one-way wire length (do not go this far!) | | | | | | |
| Model | 18 AWG | 16 AWG | 14 AWG | 12 AWG | 10 AWG | 8 AWG |
| PSR-22 | 243 ft | 386 ft | 616 ft | 976 ft | 1,551 ft | 2,463 ft |
| PSR-52 | 134 ft | 214 ft | 341 ft | 540 ft | 859 ft | 1,365 ft |
| PSR-53 | 134 ft | 214 ft | 341 ft | 540 ft | 859 ft | 1,365 ft |

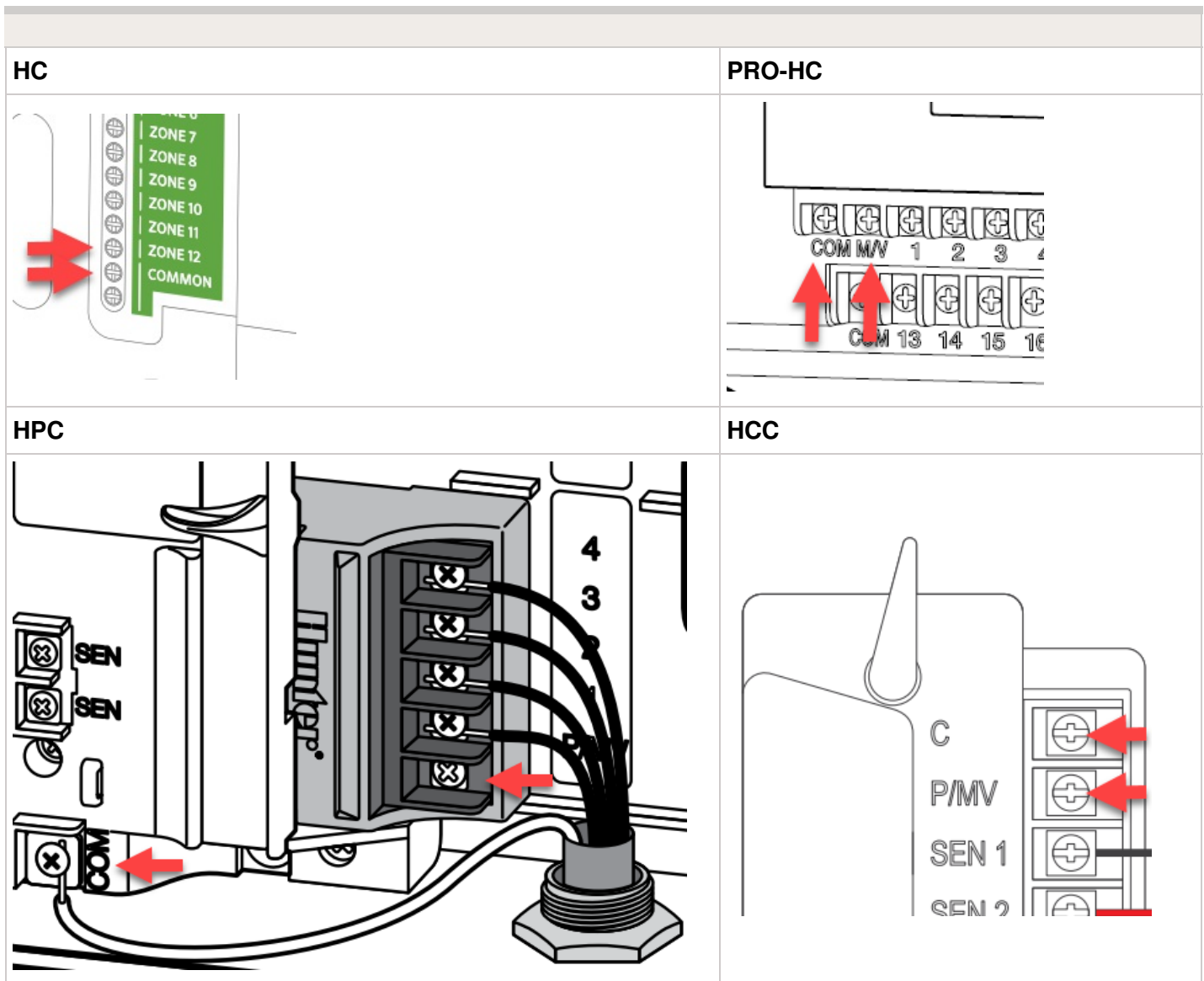

NOTE: With an HC Hydrowise controller, any one of your 6 or 12 zones can be configured to act as the pump start relay. We usually recommend wiring to the last zone that is not being used in the controller.

Wiring to Power Source

Connecting the pump start relay should only be done by a licensed electrician following local codes. Improper installation could result in shock or fire hazard.

1. To prevent electric shock, turn the main circuit-breaker switch to “off” prior to making electrical connections.
2. Assemble conduit piping and connect AC power from the power source to one side (LINE IN) of the relay.
3. Assemble conduit piping and connect wiring from the pump motor to the other side of

the relay (LOAD OUT).

4. Check to make sure there are no exposed or loose connections.

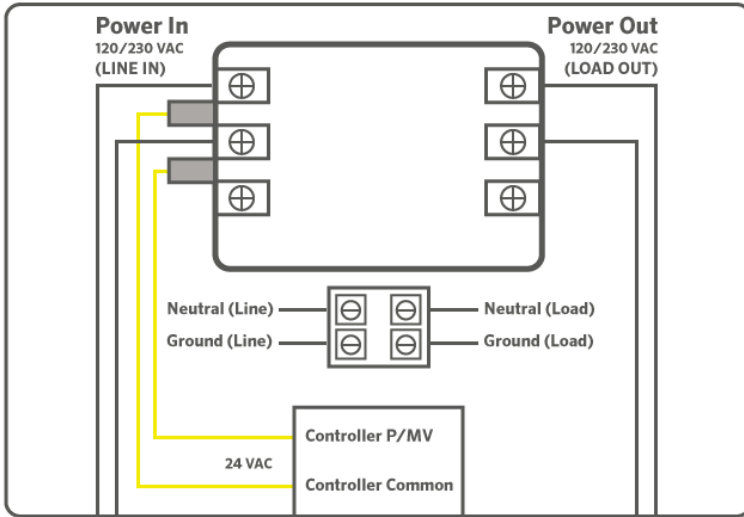

Online Setup

This setup option is prompted when you first go through the initial setup wizard in the software.

The online instructions will refer to a **MASTER VALVE** but this same setting applies when using a **PUMP START RELAY (PSR)**.

NOTE: With an HC Hydrawise controller, any one of your 6 or 12 zones can be configured to act as the pump start relay. We usually recommend wiring to the last zone that is not being used in the controller.

Does your irrigation system have a master valve?

No I don't have a Master Valve

Yes I have a Master Valve

If you need to change this in the software after the setup wizard, refer to the instructions below.

1. Log in to your Hydrawise account
2. Click on **ZONES AND SCHEDULES** for the PC or **ZONES** if using the mobile app.
3. Choose **YES** from the drop-down menu above the zones. If you have an HC controller, choose the zone number to which you have the master valve wired.

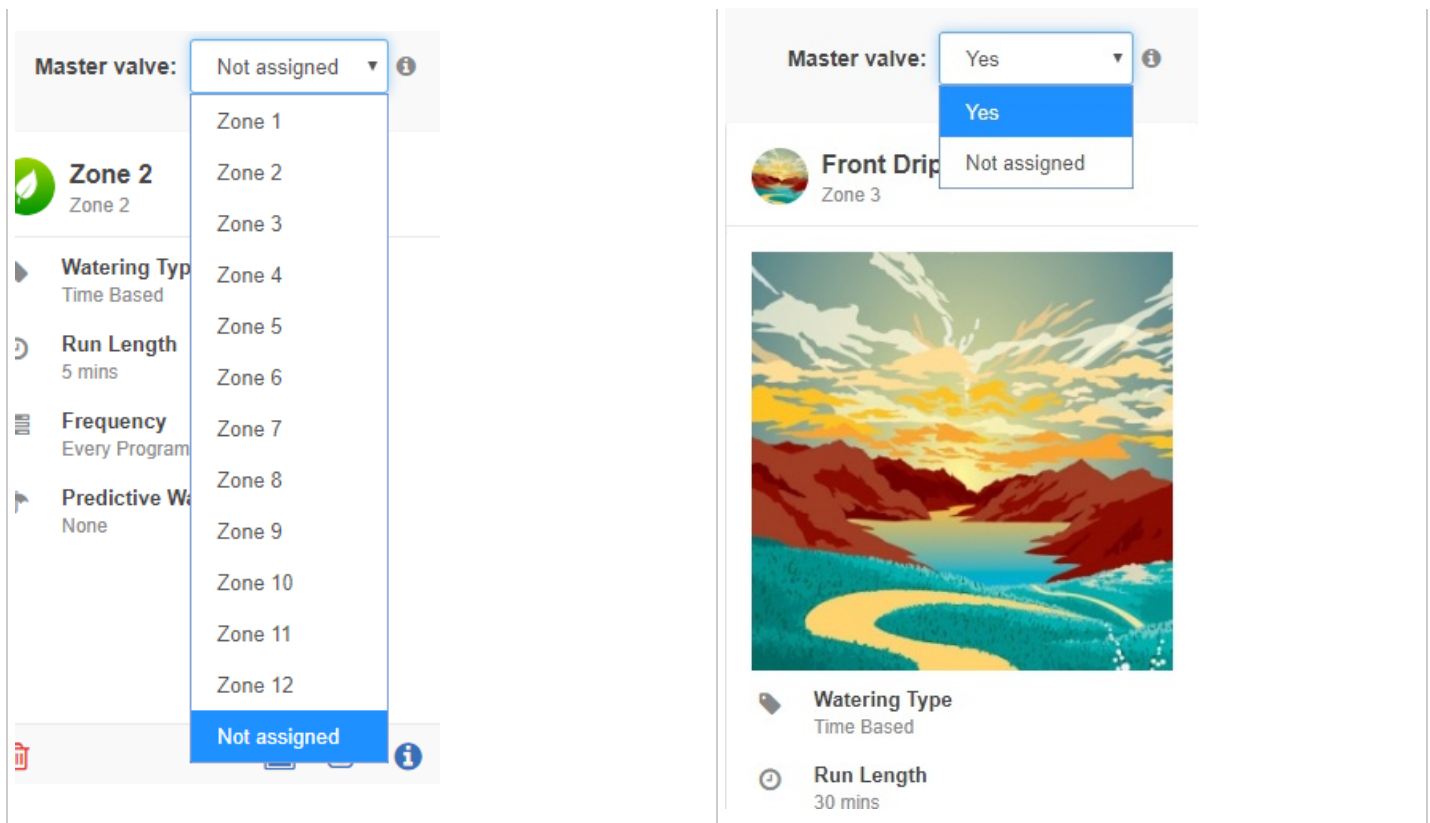

Pump Start Relay Operation per Station

When selecting a **PUMP START RELAY** to be on/off for an individual zone, you can edit the zone in **ZONES AND SCHEDULES** under **ADVANCED SETTINGS**. This option is useful when one zone is using city water and another is using water from a different source.

NOTE: This option is for HPC and HCC controllers only.

Follow the steps below to change this setting:

1. From the **ZONES AND SCHEDULES** page, click on the  icon on the zone you would like to edit.
2. Click on **ADVANCED**, which is located on the top blue search section.
3. Select **USE GLOBAL MASTER VALVE SETTING** to keep this circuit on or select **DISABLE MASTER VALVE** to turn it off.

Master valve

Use Global Master Valve Setting Disable Master Valve

Water Adjustment

Fine tune your watering if your zone appears to be too dry or wet



One Master Valve - Two Controllers

There are many times when two controllers are being supplied from a single POC (point of connection) or source of water. Hydrawise-ready controllers can be connected to a single master valve using a isolation relay (part number REL2). This device will allow for two controllers to share the same master valve with out any issues.

The few limitations include:

- Only one controller can operate at a time.
- A delay of at least five minutes between the operation of controller #1 and controller #2 is desirable.
- Electrical alerts will apply for each controller.

Steps for set up.

1. Wire the relay according to the drawing below.
2. Set up the master valve in the the app for both controllers using the normal instructions in the article [here](#) ^[28].
3. Set up a new master valve using the app for controller #2 as per normal instructions.

REL 2 is NEVER connected to high voltage. It is for 24 VAC devices only.

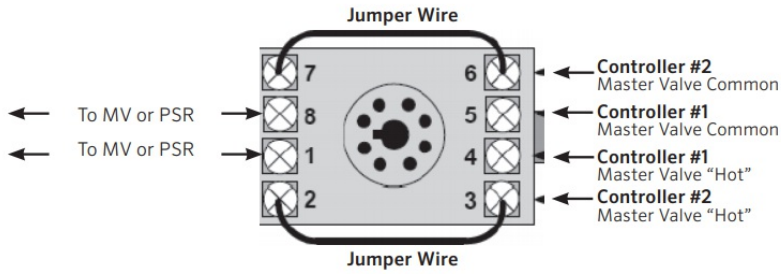

Master Valve Wiring and Online Setup

In this article, we will discuss the following topics:

- Brief Summary
- Operation Chart
- Wiring
- Setup Online
- Master Valve (P/MV) Operation per zone

Brief Summary

A master valve is a normally closed valve installed at the supply point of the main line that opens only when the automatic system is activated. Zone valves are the individual valves that operate a group of sprinklers or drip emitters. Hydramatic controllers support 6 - 54 zone valves, depending on the model. Typically one zone valve is turned on at a time and controls the irrigation in a specific area of your garden. Whenever one of the irrigation zone valves is told to open by the controller, the controller also signals the master valve to open. The purpose of the master valve is to shut off the water to the irrigation system when none of the zone valves are operating.

Operation Chart

| Controller Model | Set Master Valve Operation |
|------------------|----------------------------|
| HC | ON or OFF by All Zones |
| PRO-HC | ON or OFF by All Zones |
| | |

| | |
|-----|--------------------------------|
| HPC | ON or OFF by Zone or All Zones |
| HCC | ON or OFF by Zone or All Zones |

Wiring

1. Route the master valve wire between valve location and Hydrawise controller.
2. Attach the common wire to either solenoid wire. This is most commonly a white colored wire. Attach a separate control wire to the remaining wire of each master valve solenoid. All wire splice connections should be done using waterproof connectors.
3. Route wire through the conduit or one of the openings on the bottom of the cabinet.
4. Strip ½" (13 mm) of insulation from ends of all wires. Secure the valve common wire to “COM” (Common) terminal. Attach the opposite control wire to the M/V terminal.

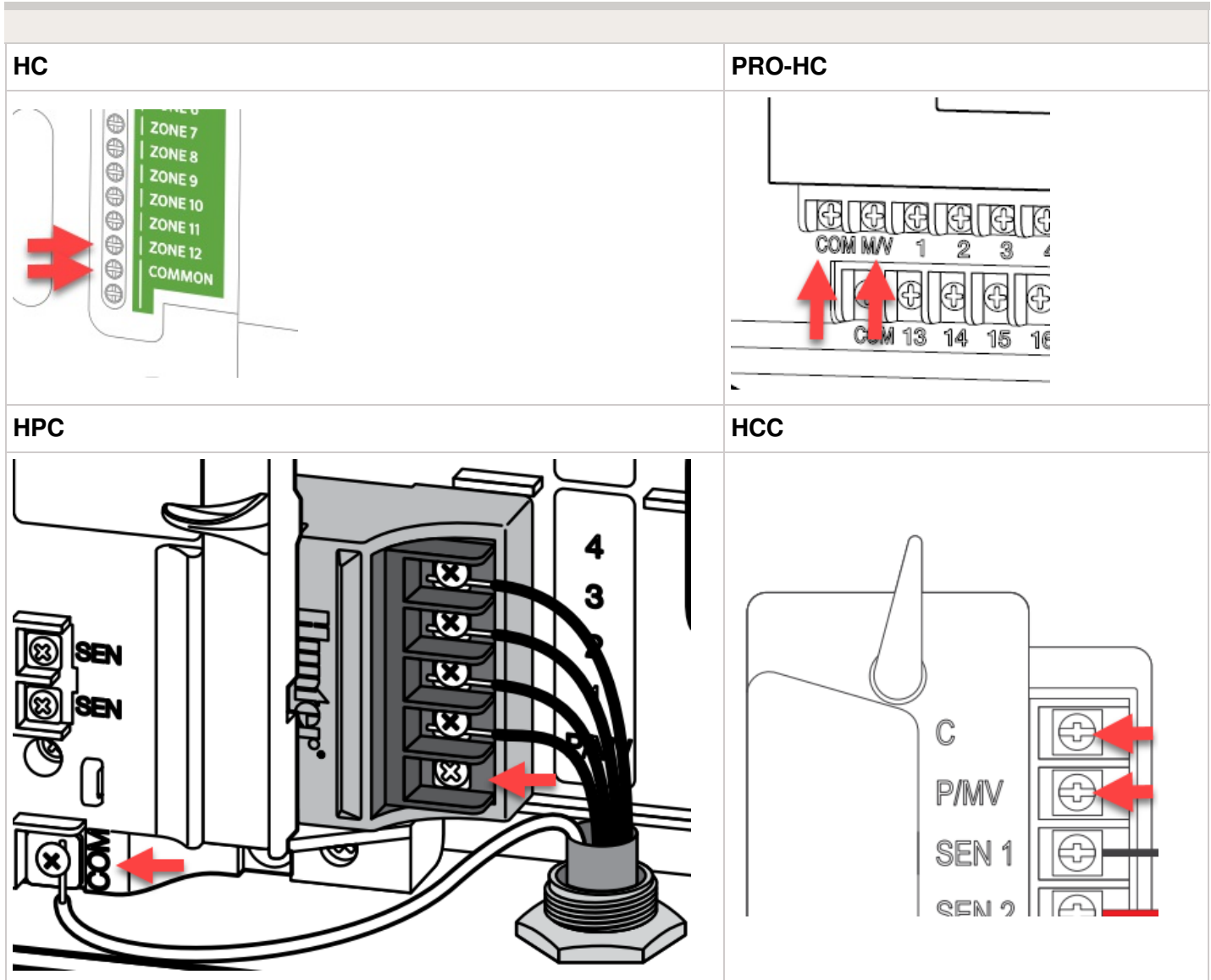

NOTE: With a HC Hydrawise controller, any one of your 6 or 12 zones can be configured

to act as a master valve. We usually recommend wiring to the last zone not used in the controller.

Setup Online

This setup option is prompted when you first go through the initial setup wizard in the software.

Does your irrigation system have a Master Valve?

No I don't have a Master Valve

Yes I have a Master Valve

[Back](#) [Continue](#)

In the event, you need to change this in the software after the setup wizard, please refer to the instructions below.

1. Login to your Hydrowise account
2. Click on **ZONES AND SCHEDULES** for the PC or **ZONES** if using the mobile app.
3. Choose **YES** from the drop-down above the zones. If you have an HC controller, then you choose the zone number that you have the master valve wired too.

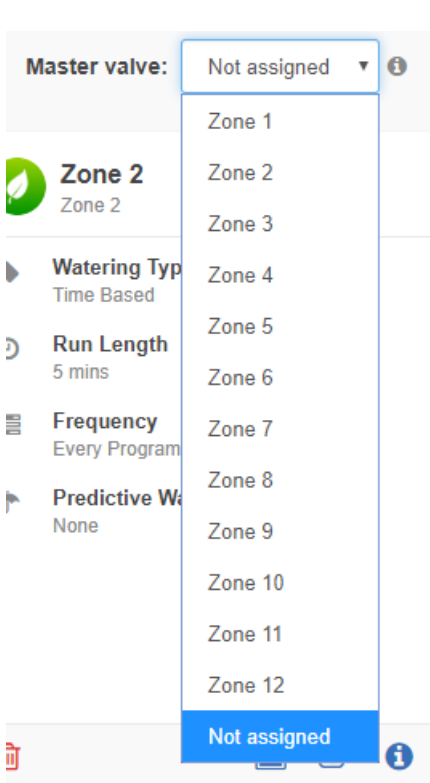
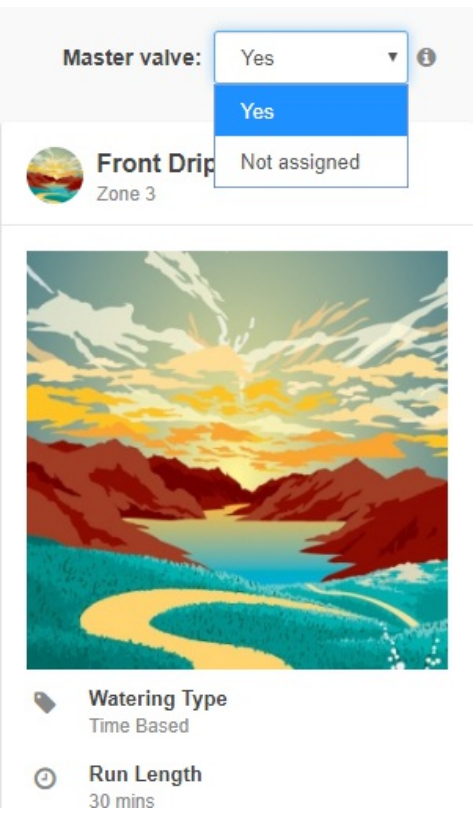
| HC Controller | PRO-HC, HPC, and HCC Controllers |
|---------------------------------------------------------------------------------------------------------------------------------------------------------------------------------------------------------------------------------------------------------------------------------------------------------------------------------------------------------------------------|----------------------------------------------------------------------------------------------------------------------------------------------------------------------------------------------------|
|  <p>Master valve: Not assigned</p> <ul style="list-style-type: none">Zone 1Zone 2Zone 3Zone 4Zone 5Zone 6Zone 7Zone 8Zone 9Zone 10Zone 11Zone 12Not assigned |  <p>Master valve: Yes</p> <p>Front Drip Zone 3</p> <p>Watering Type: Time Based</p> <p>Run Length: 30 mins</p> |

Master Valve (P/MV) Operation per Station

For selecting a master valve to be on/off for an individual zone, this can be done when editing the zone in zones and schedules under advanced settings. This option is useful when one zone is using city water and another is using from another source.

Note: This option is for HPC and HCC controllers only.

Please follow the steps below to change this setting.

1. From the **ZONES AND SCHEDULES** page, click on the  icon on the zone you would like to edit.
2. Click on **ADVANCED** located on the top blue search section.
3. Select Use **GLOBAL MASTER VALVE SETTING** to keep this circuit on or select **DISABLE MASTER VALVE** to turn this circuit off.

Master valve

Use Global Master Valve Setting Disable Master Valve

Water Adjustment

Fine tune your watering if your zone appears to be too dry or wet



Sprinklers Running with the Controller Off or Unplugged

There are two reasons why sprinklers would continue to run with the controller **Off** or **Unplugged**:

- It's possible your valves were opened manually. Locate your valve box(es) and turn the solenoid(s) clockwise until snug. The solenoid is located on top of the valve and looks like a cylinder with two wires protruding out of it.
- It's also possible that debris in the valve is causing the diaphragm to remain open.

To fix this problem:

1. Disassemble the valve.
2. Rinse all parts with clean water.
3. Reassemble the valve.

If you cannot locate your valves, contact the contractor who installed the system.

Cleaning the Diaphragm on a Hunter Valve

